

# Centrifugal Roof Exhaust Fans Series L Low Silhouette

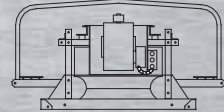
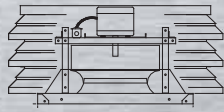

 **GREENHECK**  
Building Value in Air.

April  
2016

# Series L Centrifugal Roof Exhaust Fans



Series L, **low silhouette**, centrifugal roof exhaust fans provide the industry's **broadest performance** and **durability** for general clean air applications. These products undergo extensive **life testing**, assuring these fans will provide years of **reliable** performance.

## Typical Installations

- Educational Facilities
- Warehouses
- Office Buildings
- Shopping Centers

## Benefits

- Quick motor and drive access
- Excellent weather resistance
- Certified for severe duty applications

## Table of Contents

Unique Construction Features . . . . .	3-5	Severe Duty Dimensions and Installation . . . . .	11-12
Standard Installation . . . . .	6	Dimensions	
Severe Duty Option . . . . .	7	LD/LDP Direct Drive . . . . .	13-15
Vari-Green Motor and Control Options . . . . .	8-9	LB/LBP Belt Drive . . . . .	16-25
Options and Accessories . . . . .	10	Specifications . . . . .	26-27



## Fabra Hood Style

- **Hinged Hood** - All sizes feature a hood which may be hinged to provide quick access to the motor and drive assembly. Access may be gained by simply removing two of the four hood fasteners or all fasteners for complete removal.
- **Large Interior Dimensions** - All sizes allow complete accessibility. Interior dimensions offer clearance for inspection, cleaning, or maintenance of the motor, wheel, belt(s), and drives.
- **Strength & Weather Resistance** - The hood is designed with arched panels manufactured of heavy gauge, precision roll formed steel with interlocking edges. Each interlocking rib creates a tight, weather resistant seal. Heavy gauge steel support members provide structural strength.

Greenheck's interlocking rib design combines four material thicknesses with I-beam design principles producing a hood far superior in strength to conventional designs (an important feature in high wind and snow load regions).

Formed channels adjacent to the ribs provide water drainage to ensure weather tightness.

Hoods are available in galvanized steel, coated steel, or aluminum construction.

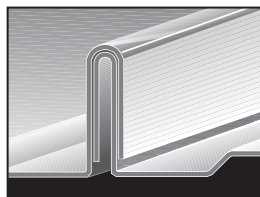

## Louvered Penthouse Style

- **Hinged Cover** - All sizes feature an aluminum cover which may be hinged to provide quick access to the motor and drive assembly. Covers are fastened down with a quick release hood latch.
- **Large Interior Dimensions** - All sizes allow complete accessibility from above. Interior dimensions offer clearance for inspection, cleaning, or maintenance of the motor, wheel, belt(s), and drives.
- **Strength & Weather Resistant** - Each unit features storm resistant aluminum louver blades with mitered corners. For decades, our storm resistant blades have proven highly effective. Each sturdy extruded aluminum louver blade has a material thickness of 0.080 inches.

Greenheck's louvered penthouse hoods feature heavy gauge extruded aluminum louvers with mitered corners for a clean, finished appearance and weather resistant construction.

The interior vertical edge of the curb cap forms the throat and weathershield. Each corner is also shielded to prevent leakage.

Penthouses are available in aluminum for lasting durability and appearance.

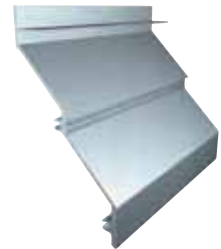

Greenheck Fan Corporation certifies the models LD, LDP, LB, and LBP shown herein are licensed to bear the AMCA seal. The ratings shown are based on tests and procedures performed in accordance with AMCA Publication 211 and AMCA Publication 311 and comply with the requirements of the AMCA Certified Ratings Program.



\*UL is optional and must be specified. Models LD, LDP, LB, and LBP are listed for electrical (UL/cUL 705) File no. E40001.



## Fabra Hood Style

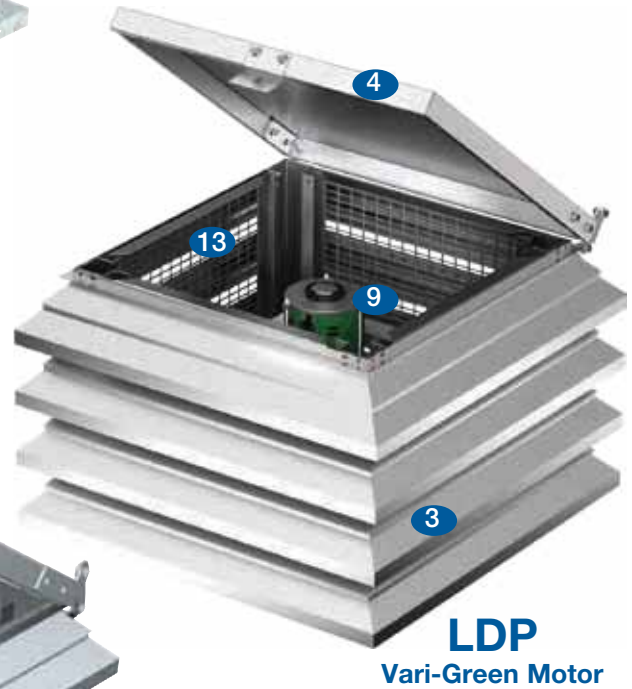
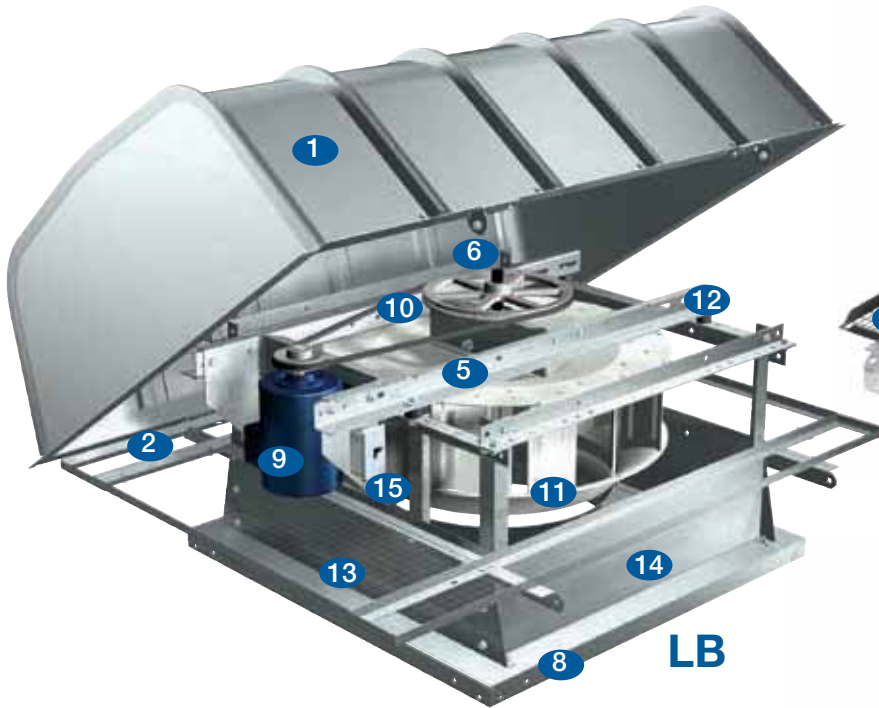

## Louvered Penthouse Style

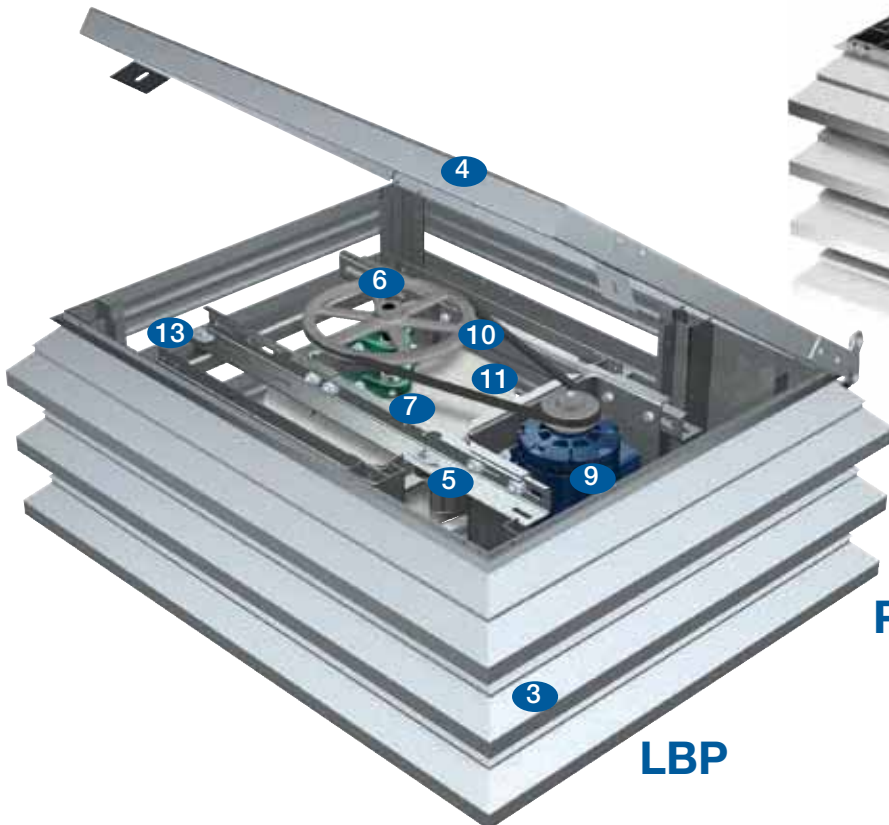



Standard Construction Features	
<b>1</b>	<b>Fabra Hood Style</b> Models LD and LB have a rib-lock galvanized housing. Hood panels are interlocked and attached to sturdy galvanized rails. (Aluminum housings are optional).
<b>2</b>	<b>Hinged Access</b> The entire hood assembly on models LD and LB can be hinged open for access to the internal fan components.
<b>3</b>	<b>Louvered Penthouse</b> Models LDP and LBP penthouse style housings are constructed of heavy extruded aluminum louvers with mitered and welded corners.
<b>4</b>	<b>Hood Cover</b> Models LDP and LBP aluminum hood covers are hinged and removable for access.
<b>5</b>	<b>Drive Frame</b> Constructed from heavy gauge galvanized steel. Belt adjustment is accomplished by loosening fasteners, sliding the motor plate, and retightening fasteners.
<b>6</b>	<b>Fan Shaft</b> Precisely sized, ground, and polished so the first critical speed is at least 25% over the maximum operating speed. Close tolerances between the shaft and bearing result in longer bearing life.
<b>7</b>	<b>Bearings</b> 100% factory tested and designed specifically for air handling applications with a minimum L <sub>10</sub> life in excess of 100,000 hours (L <sub>50</sub> average life of 500,000 hours).
<b>8</b>	<b>Curb Cap</b> Curb cap has prepunched mounting holes to ensure correct attachment to the curb.
<b>9</b>	<b>Motor</b> All motors are carefully matched to the fan load to provide years of trouble-free operation.
<b>10</b>	<b>Drive Assembly</b> Drives are oversized 150% of driven horsepower. Machined cast iron pulleys are factory set to the required RPM and are adjustable for final system balancing. Belts are static free and oil resistant.
<b>11</b>	<b>Wheel</b> An aluminum, backward inclined, non-overloading, centrifugal wheel is utilized to deliver maximum efficiency. Each wheel is statically and dynamically balanced.
<b>12</b>	<b>Vibration Isolators</b> Support the drive assembly and wheel without steel to steel contact providing long life and quiet operation.
<b>13</b>	<b>Birdscreen</b> Galvanized rigid wire protects the fan's discharge from birds or small objects. (Aluminum birdscreen is optional).
<b>14</b>	<b>Windband</b> Lower windband assembly ensures weathertight and rigid unit construction.
<b>15</b>	<b>Disconnect Switch</b> NEMA-1 switch is factory mounted. Wiring from the motor to the disconnect enclosure is provided as standard. All wiring and electrical components comply with the National Electric Codes (NEC) and are UL Listed or Recognized.
	<b>Conduit Chase</b> A large diameter conduit for installing electrical wiring through the curb cap into the motor compartment. (Not shown)

# Standard Installation



Models LB, LD, LBP, and LDP exhaust fans are designed to meet the needs of general clean air applications. Tests have been conducted to ensure safe and reliable fans capable of withstanding normal exhaust conditions.

When roofing materials extend to the top of the curb, roof curbs should be  $1\frac{1}{2}$  in. (38 mm) ( $\frac{3}{4}$  in. (19 mm) on a side) less than the unit curb cap to allow for roofing and flashing.

For recommended duct size, damper size, and roof opening dimensions, refer to CAPS or the performance data pages.

Installation must include a means for inspecting, cleaning, and servicing the exhaust fan.

Due to the varying airstreams encountered in commercial ventilation, system designers must be aware of national, state, and local codes and guidelines governing these installations. Local code authorities should be consulted before proceeding with any ventilation project.

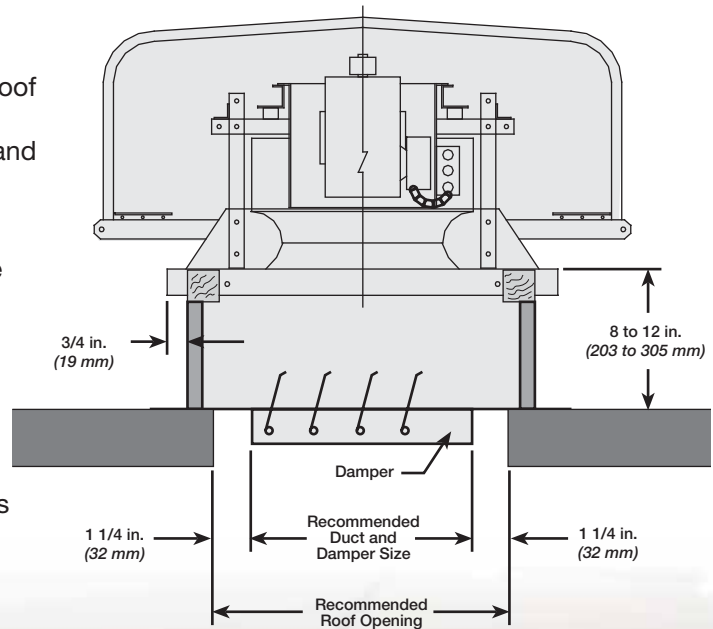

# Severe Duty Option

Specifically designed for applications with extremely high structural design load requirements. The severe duty models LDP and LBP are far superior to any centrifugal roof exhaust fan currently in the market. The LBP/LDP may be used in any application which requires a fan to endure high winds with the potential of wind blown debris. The louvered housing has been tested in accordance with the following Miami-Dade test protocols:

- Large Missile Impact Test - TAS-201-94
- Uniform Static Air Pressure - TAS-202-94
- Uniform Cyclic Wind Loading - TAS-203-94

*To meet the above protocols, the severe duty fan must be mounted on a severe duty roof curb, which is attached directly to the building structure. Maximum design load is 140 psf.*

Available on sizes

- LDP 60 through 120
- LBP 10 through 30

*Weights and dimensions will vary from standard LDP and LBP construction.*



NOTICE OF ACCEPTANCE  
NUMBER 14-0514.07

## Severe Duty Installation

Models LDP and LBP severe duty exhaust fans are designed to meet the needs of general clean air applications. Tests have been conducted to ensure safe, rugged and reliable fans capable of withstanding severe exhaust conditions.

Installation must include a means for inspecting, cleaning, and servicing the exhaust fan.

Due to the varying airstreams encountered in commercial ventilation, system designers must be aware of national, state, and local codes and guidelines governing these installations. Local code authorities should be consulted before proceeding with any ventilation project.

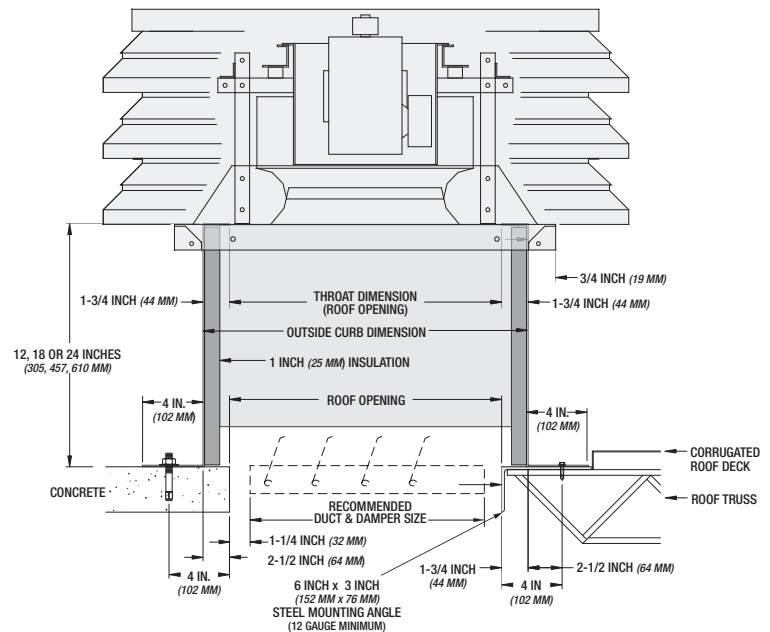



## Model LD/LDP VARI-GREEN

Greenheck's electronically commutated (EC) Vari-Green (VG) motor combines motor technology, controllability and energy-efficiency into one single low maintenance unit and is the industry's first fully controllable motor. When combined with Greenheck's Series L fans, all the CFM and static pressure ranges of a belt drive can be attained with the benefits of a direct drive.

Motor Information			
HP	RPM	Voltage	HZ
1/6	1725	115, 208-240, 277	50/60
1/4	1725	115, 208-240, 277	50/60
1/2	1725	115, 208-240, 277	50/60

### Benefits

Operates on AC power that's converted to DC—providing a more efficient motor operation as compared to an AC operation.

- The motor can attain up to 85% efficiency and reduce energy consumption.
- Watt savings of 30-70% depending on RPM. Note: As motor speed is turned down, efficiency stays high as compared to an AC motor that decreases dramatically.
- Operates cooler than a standard AC motor at lower RPMs. A cooler motor has longer motor life and reduces energy consumption.
- 80% usable RPM turndown versus 30%, see Motor Turndown Comparison chart at right.
- Series L fans with Vari-Green motors can provide all the CFM and static pressure ranges of a comparable belt drive.
- Maintenance costs are reduced as there are no belts or bearings to replace and no pulleys to adjust.
- Direct drive fans are often preferred where maintenance access is difficult.
- Provides a solution for demand controlled ventilation applications.

### Vari-Green Advantages

- Initial cost is similar to a belt drive
- Lower operating cost
- No maintenance, no belts, pulleys or bearings
- Easy RPM adjustment

### Features

1. Dial on Motor Control - a potentiometer (dial on motor control) is mounted on the motor for easy speed adjustment for system balance. Simply turn the dial. There are no belts and pulleys to adjust.
2. Control Wire Inputs - the motor accepts a 0-10V DC signal from Building Automated Systems or other controls to adjust motor speed.



### Comparisons: Belt, Direct Drive with PSC and Direct Drive with Vari-Green

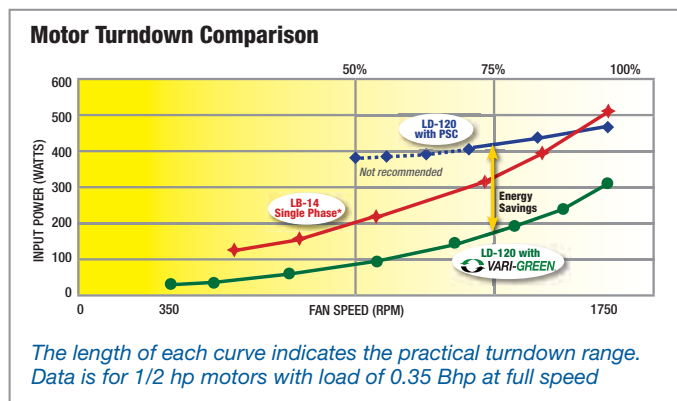

### Constant Volume Life Cycle Analysis

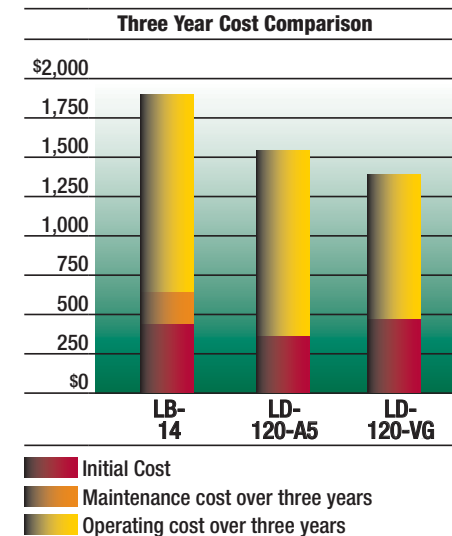

*Analysis is based on operating costs for a period of three years where the fans operate continuously at 1725 rpm, 24/7, with an energy rate of \$0.10/kWh. Maintenance on the LB-14 is estimated at \$65/yr.*

*Note: Example is based on a relative cost. Use and installation variables may produce different results.*



## Demand Control Ventilation for Multistory Buildings

Applications requiring constant pressure or variable volume can utilize Series L fans with Vari-Green motors and Vari-Green controls. Demand control ventilation systems reduce the amount of energy used by decreasing the speed of the fan when demand is low. This in turn lessens the amount of conditioned air exhausted and further reduces total operating costs associated with air conditioning and heating in multistoried buildings such as hotels, multifamily complexes, institutional facilities, and high rise commercial buildings.

### Variable Volume Operating Cost Analysis

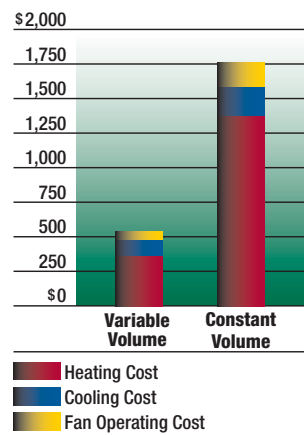

*Example of potential savings based on a northeast city in the USA using Vari-Green components for variable volume.*

The Vari-Green constant pressure control is preprogrammed and easy to install for applications that include venting dryers, bathrooms, residential type kitchen space or industrial process exhaust.

Contact [fans@greenheck.com](mailto:fans@greenheck.com) for more information.

### Daily Operating Comparison: Variable Volume and Constant Volume

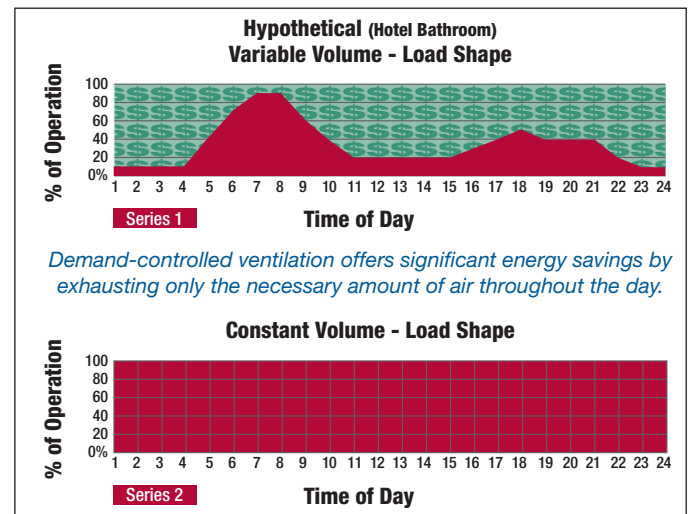

*Demand-controlled ventilation offers significant energy savings by exhausting only the necessary amount of air throughout the day.*

Note: A standard VFD compatible motor can also function within a Variable Volume system.

## Vari-Green® Controls

**Transformer** - Provides 24V power from the existing line voltage at the fan to the Vari-Green motor and controls. Dual voltage primary (120/240V) transformer provided with the fan.

**Remote Dial** - Allows for remote, manual airflow adjustments. Wall plate with dial may be mounted in a standard 2x4 inch electrical junction box.

**Two Speed Control with Integral Transformer** Control allows motor to be set at two independent speeds (high or low). Meets minimum airflow requirements with the ability to bump up to high speed in an emergency or meet maximum airflow requirements, or reset down to low for energy conservation.

**Constant Pressure Control** - Control a fan with a Vari-Green motor to maintain either a constant static pressure (variable volume) or constant velocity pressure (constant airflow). The constant pressure control is available with an integral or remote pressure transducer which provides excellent installation flexibility. Inputs include remote override (digital, dry contact) and remote setpoint (analog, 0-10V). Outputs include fan speed (0-10V), pressure/airflow reference (analog, 0-10V), and relay output (digital, 0.5A rating).

- Constant Pressure Applications – Apartments, condos, hotels; clothes dryers, residential kitchens and bathrooms.
- Constant Airflow Applications – Filtered or other variable resistance systems. The Constant Airflow control is available with Greenheck’s Airflow Measuring Station (AMS) for airflow sampling

**Air Quality – VOC** - Control a Vari-Green motor via changes in volatile organic compounds (VOC’s). VOC’s are gasses that are emitted from humans, building materials, perfumes, foods, and furniture off-gassing. Range is 0-2000 CO<sub>2</sub> PPM equivalent.

- Institutional facilities – Schools, court house, hospitals; bathrooms, waiting rooms, cafeteria.
- Commercial buildings – Office space, conference rooms, bathrooms, break room.

**Air Quality – Temperature and Humidity** - Control Vari-Green motor via changes in temperature, humidity, or both. Range is 15 to 130°F and 0 to 100% relative humidity.

- Multifamily structures - Apartments, condos, hotels; bathrooms, utility rooms.
- Commercial buildings - Office buildings, office space, conference rooms, utility rooms, bathrooms.

# Options and Accessories



**BIRDSCREEN** - Galvanized mesh is standard. Optional aluminum or stainless steel rigid wire are also available.

**HOOD INSULATION** - Hood insulation is dual-density to minimize condensation, reduce thermal transfer, and enhance sound absorption at high and low frequencies.

**LIFTING LUGS** - Four heavy gauge steel brackets are available to provide lifting points when raising the fan to the roof.

**TIE DOWN POINTS** - Four heavy gauge steel brackets are available to secure the fan in heavy wind applications. Cables and anchors by others.

**COATINGS** - Additional information on Greenheck coatings can be found in our Performance Coatings for Commercial & Industrial Fans and our Product Application Guide, Performance Coatings for Ventilation Products. A wide variety of coatings and colors are available in two categories:

**Decorative coatings** – Standard colors are available.

**Protective coatings** – Electrostatic applied powder coatings are available to protect against most environments.

**DAMPERS** - Designed to prevent outside air from entering back into the building when fan is off. Options include gravity and motorized dampers. Damper sizes are shown on each performance data page.

**CURB SEAL** - Rubber seal between fan and curb to ensure proper sealing when attached to a curb.



## DISCONNECT SWITCHES -

A wide selection of NEMA rated switches are available for positive electrical shutoff and safety, including: dust-tight, rainproof, and corrosion-resistant. Switches may be internally or externally mounted.



**SPEED CONTROLLERS** - Available for use with shaded pole and permanent split capacitor (PSC) open motors on models LD and LDP fans. They provide an economical means of system balancing with direct drive fans.

**CURB EXTENSIONS** - Extensions raise the fan discharge above the roof line and provide an accessible mounting location for dampers.

Insect screen bases constructed with a removable fine mesh are recommended for applications where insect entry must be prevented.

Curb extensions are not available with LDP and LBP severe duty construction models.



**ROOF CURBS** - Prefabricated roof curbs reduce installation time and costs by ensuring compatibility between the fan, curb and roof opening. All curbs are insulated with fiberglass. A wide variety of roof curbs are available including flanged, pitched and sound-absorbing.

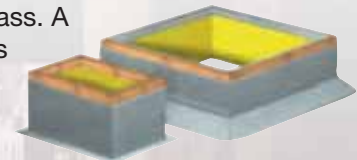

## MOTOR STARTERS

The fundamental function of a motor starter is to protect the motor from damage that can occur from overheating. With a Greenheck motor starter you will be provided with the best motor protection available.



## LDP - SEVERE DUTY DIMENSIONS

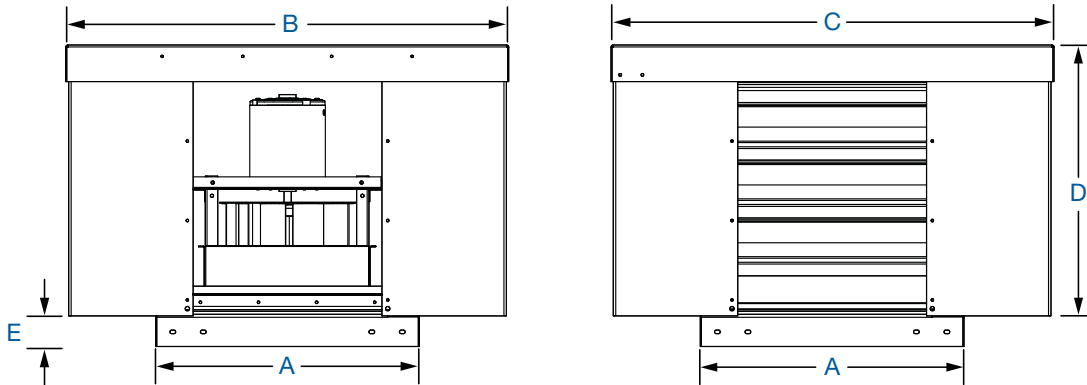

Model Number	A	B	C	D	E	Damper Size (square)	Roof Opening (square)	Weight*	Cover Thickness	Louver Thickness	Curb Cap Thickness	
LDP	60								0.100 (0.045) aluminum	0.125 (0.056) aluminum	0.25 (0.113) steel	
	65	17	34 <sup>7</sup> / <sub>8</sub>	34 <sup>7</sup> / <sub>8</sub>	17 <sup>7</sup> / <sub>8</sub>	1 <sup>3</sup> / <sub>4</sub>	8	10 <sup>1</sup> / <sub>2</sub>				375
	70	(432)	(886)	(886)	(448)	(44)	(203)	(267)				(170)
	75											
	80											
	85	19	36 <sup>7</sup> / <sub>8</sub>	36 <sup>7</sup> / <sub>8</sub>	17 <sup>7</sup> / <sub>8</sub>	1 <sup>3</sup> / <sub>4</sub>	10	12 <sup>1</sup> / <sub>2</sub>				400
	90	(483)	(934)	(934)	(448)	(44)	(254)	(318)				(181)
	95											
100	22	39 <sup>7</sup> / <sub>8</sub>	39 <sup>7</sup> / <sub>8</sub>	19 <sup>5</sup> / <sub>8</sub>	1 <sup>3</sup> / <sub>4</sub>	12	14 <sup>1</sup> / <sub>2</sub>	425				
120	(559)	(1013)	(1013)	(498)	(44)	(305)	(368)	(193)				

All dimensions are in inches (millimeters). Weight in pounds (kilograms). \*Weight shown is the largest cataloged Open Drip Proof motor.

## LBP - SEVERE DUTY DIMENSIONS

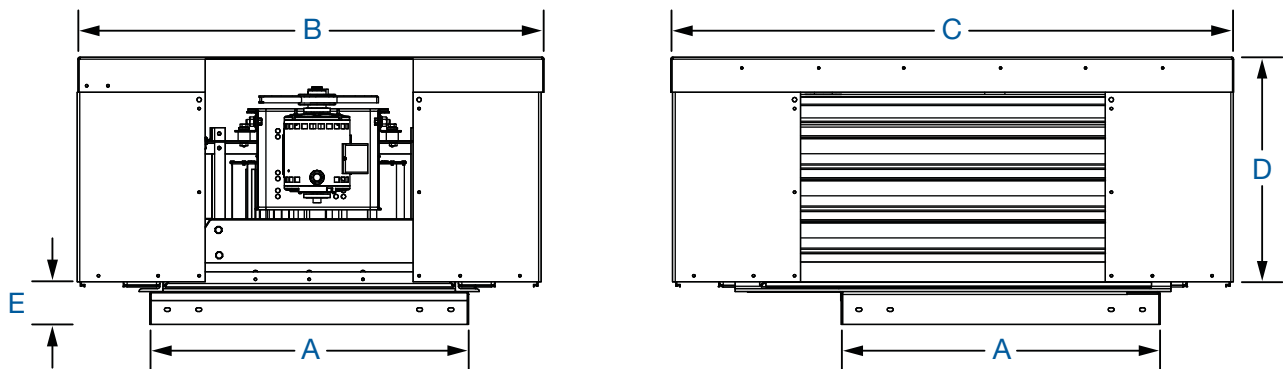

Model Number	A	B	C	D	E	Damper Size (square)	Roof Opening (square)	Weight*	Cover Thickness	Louver Thickness	Curb Cap Thickness	
LBP	10	22	39 <sup>7</sup> / <sub>8</sub>	50 <sup>3</sup> / <sub>8</sub>	18 <sup>1</sup> / <sub>8</sub>	1 <sup>3</sup> / <sub>4</sub>	12	10 <sup>1</sup> / <sub>2</sub>	550	0.100 (0.045) aluminum	0.125 (0.056) aluminum	0.25 (0.113) steel
		(559)	(1013)	(1280)	(460)	(44)	(305)	(267)	(249)			
	14	26	43 <sup>7</sup> / <sub>8</sub>	51 <sup>7</sup> / <sub>8</sub>	18 <sup>1</sup> / <sub>8</sub>	1 <sup>3</sup> / <sub>4</sub>	16	10 <sup>1</sup> / <sub>2</sub>	550			
		(660)	(1114)	(1318)	(460)	(44)	(406)	(267)	(249)			
	18	30	47 <sup>7</sup> / <sub>8</sub>	57 <sup>7</sup> / <sub>8</sub>	24 <sup>5</sup> / <sub>8</sub>	1 <sup>3</sup> / <sub>4</sub>	18	10 <sup>1</sup> / <sub>2</sub>	550			
		(762)	(1216)	(1470)	(625)	(44)	(457)	(267)	(249)			
	21							10 <sup>1</sup> / <sub>2</sub>	700			
							(267)	(318)				
24	34	51 <sup>7</sup> / <sub>8</sub>	61 <sup>7</sup> / <sub>8</sub>	24 <sup>5</sup> / <sub>8</sub>	1 <sup>3</sup> / <sub>4</sub>	24	10 <sup>1</sup> / <sub>2</sub>	800				
	(864)	(1318)	(1572)	(625)	(44)	(610)	(267)	(363)				
30	40	57 <sup>7</sup> / <sub>8</sub>	69 <sup>7</sup> / <sub>8</sub>	27 <sup>1</sup> / <sub>4</sub>	1 <sup>3</sup> / <sub>4</sub>	30	10 <sup>1</sup> / <sub>2</sub>	950				
	(1016)	(1470)	(1775)	(692)	(44)	(762)	(267)	(431)				

All dimensions are in inches (millimeters). Weight in pounds (kilograms). \*Weight shown is the largest cataloged Open Drip Proof motor.



# Severe Duty Curb Installation Options



## Concrete

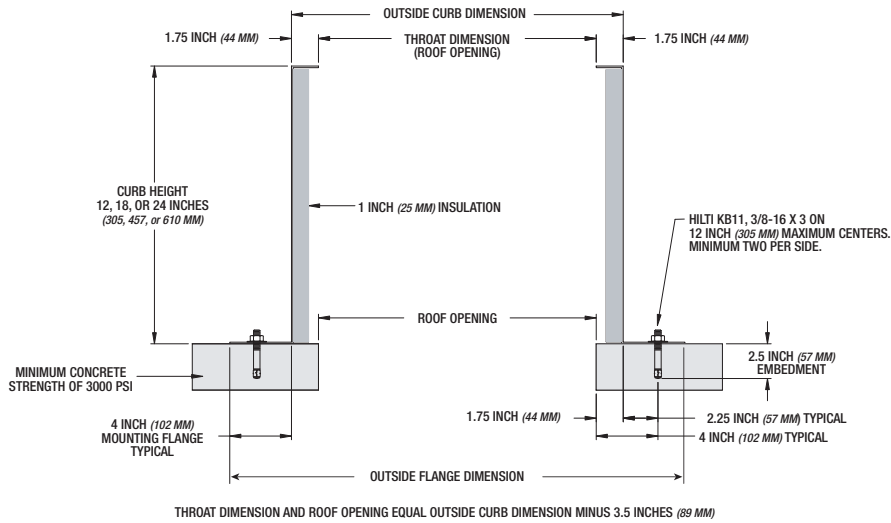

## Steel

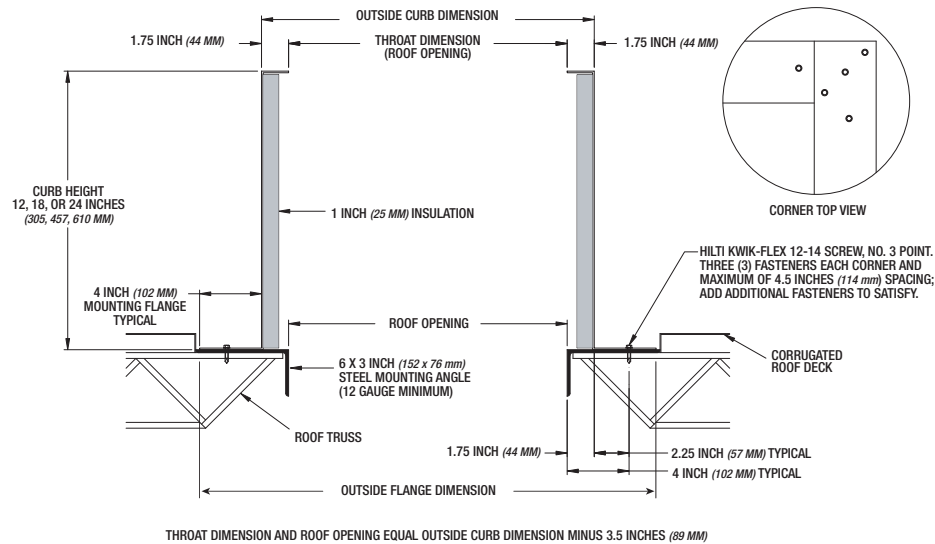

## Model Number Code

The model number system is designed to completely identify the fan. The correct code letters must be specified to designate belt or direct drive. The remainder of the model number is determined by the size and performance selected from the following pages.

**LB - 30 - VG/7**

### Model

- LD - Fabra Hood Direct Drive
- LB - Fabra Hood Belt Drive
- LDP - Louvered Penthouse Direct Drive
- LBP - Louvered Penthouse Belt Drive

### Fan Size

- LD/LDP 60 thru 120
- LB/LBP 10 thru 54

**VG = Vari-Green** (Direct Drive only)

**Motor hp** (Belt Drive only)

- |         |            |            |
|---------|------------|------------|
| 6 = 1/6 | 10 = 1     | 50 = 5     |
| 4 = 1/4 | 15 = 1 1/2 | 75 = 7 1/2 |
| 3 = 1/3 | 20 = 2     | 100 = 10   |
| 5 = 1/2 | 30 = 3     | 150 = 15   |
| 7 = 3/4 |            |            |

**Motor RPM** (Direct Drive only)

- A = 1725
- B = 1140
- C = 860

**International**

(see CAPS for Performance)

- K = 950 RPM
- J = 1475 RPM

# LD/LDP 60-75

## Direct Drive



### LD Dimensions

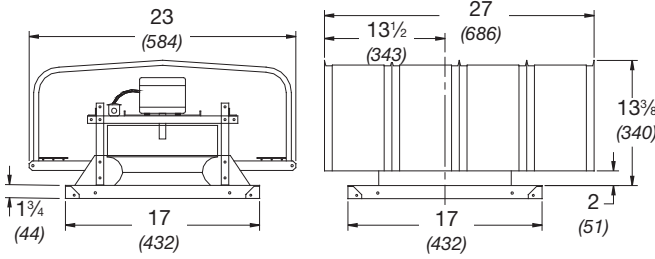

### LDP Dimensions

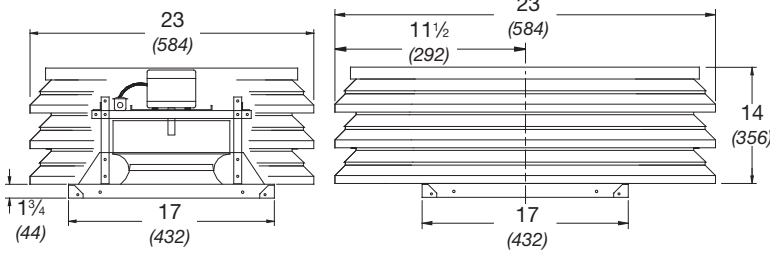

	LD 60 thru LD 75	LDP 60 thru LDP 75
Hood Thickness	24 ga	-
Cover Thickness	-	0.064 (0.029)
Louver Thickness	-	0.081 (0.036)
Curb Cap Thickness	0.064 (0.029)	0.064 (0.029)
Damper Size Square	8 (203)	8 (203)
Roof Opening Square	10 1/2 (267)	10 1/2 (267)
Weight*	Galvanized 37 (17)	Aluminum 49 (22)

All dimensions are in inches (millimeters). Weight in pounds (kilograms).

\*Weight shown is the largest cataloged Open Drip Proof motor.

See page 11 for severe duty LDP dimensions.

Size 60 and 65

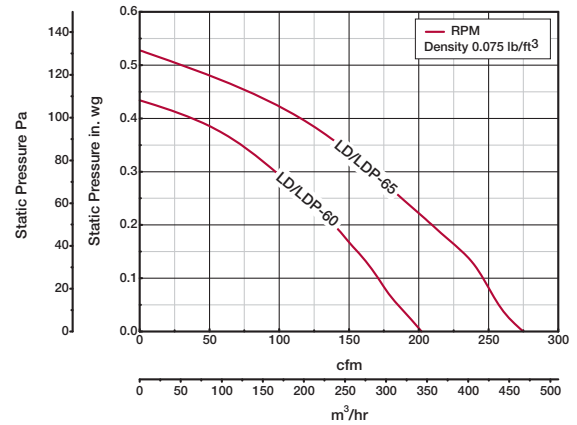

Size 70 and 75

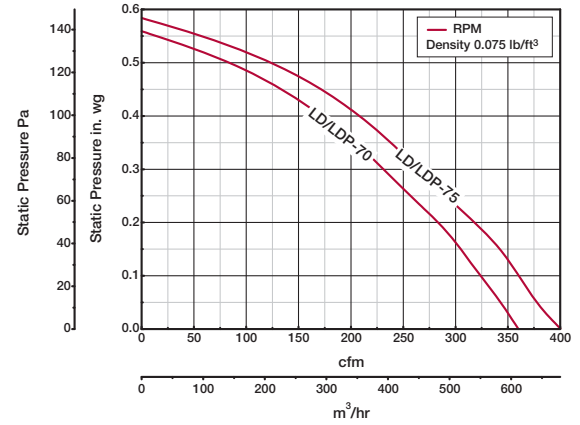

Model Number	Motor HP	Fan RPM	Watts		CFM / Static Pressure in Inches wg										
					0	0.1	0.125	0.2	0.25	0.3	0.375	0.4	0.45	0.5	
LD/LDP-60	1/60	1590*	51 W	CFM	202	171	164	139	119	97					
				Sones	4.8	4.3	4.3	4.0	3.8	3.6					
LD/LDP-65	1/30	1680*	70 W	CFM	274	245	238	208	187	165	129	112			
				Sones	5.6	5.3	5.2	5.0	5.1	5.1	5.1	5.2			
LD/LDP-70	1/30	1665*	73 W	CFM	360	324	314	282	257	231	188	171	132		
				Sones	6.4	6.0	5.9	5.5	5.4	5.3	5.2	5.1	5.0		
LD/LDP-75	1/25	1620*	79 W	CFM	400	360	351	317	290	264	222	206	168	122	
				Sones	5.8	5.2	5.1	4.9	4.7	4.5	4.2	4.1	4.0	3.8	

Performance certified is for installation type A: Free inlet, Free outlet. Power rating (Bhp) does not include transmission losses. Performance ratings include the effects of a birdscreen in the airstream. \*Speed (RPM) shown is nominal. Performance is based on actual speed of test. The sound ratings shown are loudness values in fan sones at 5 feet (1.5 m) in a hemispherical free field calculated per AMCA Standard 301. Values shown are for installation type A: Free inlet hemispherical sones.

# LD/LDP 80-95

## Direct Drive VG



### LD Dimensions

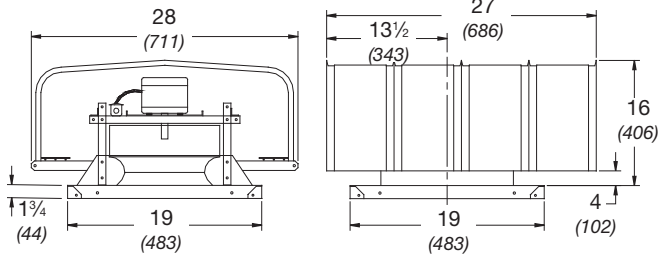

### LDP Dimensions

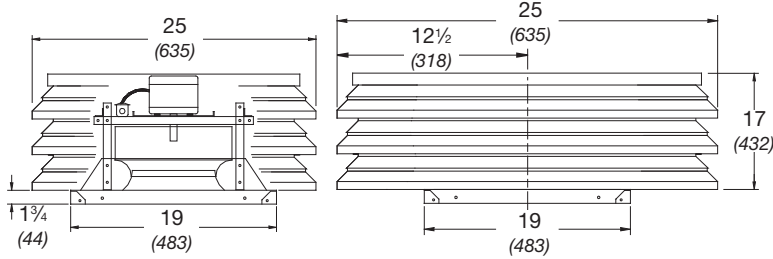

	LD 80 thru LD 95	LDP 80 thru LDP 95
Hood Thickness	24 ga	-
Cover Thickness	-	0.064 (0.029)
Louver Thickness	-	0.081 (0.036)
Curb Cap Thickness	0.064 (0.029)	0.064 (0.029)
Damper Size Square	10 (254)	10 (254)
Roof Opening Square	12 1/2 (318)	12 1/2 (318)
Weight*	Galvanized 45 (20)	Aluminum 63 (29)

All dimensions are in inches (millimeters). Weight in pounds (kilograms).  
 \*Weight shown is the largest cataloged Open Drip Proof motor.  
 See page 11 for severe duty LDP dimensions.

Size 80 and 85

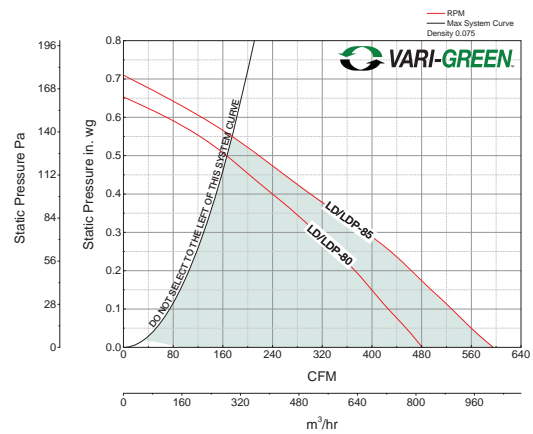

Size 90 and 95

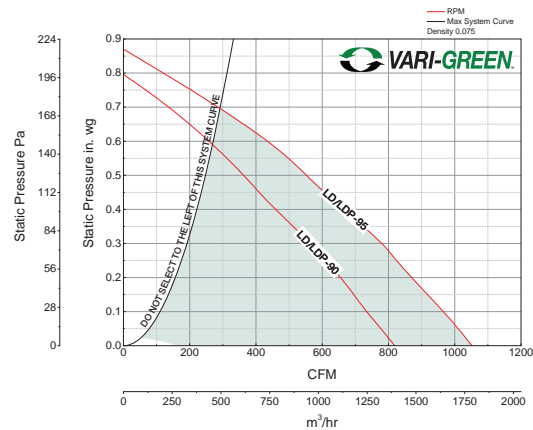

Model Number	Motor HP	VG HP	Fan RPM	Watts	CFM / Static Pressure in Inches wg										
					0	0.1	0.125	0.2	0.25	0.3	0.375	0.5	0.6	0.625	
LD/LDP-80	1/20	1/6	1550*	115 W	CFM	481	426	413	372	342	310	258	165		
					Sones	8.8	8.2	8.0	7.8	7.6	7.4	7.2	7.5		
LD/LDP-85	1/20	1/6	1500*	120 W	CFM	576	507	490	440	403	360	291	182		
					Sones	8.6	8.1	8.0	7.7	7.3	7.1	7.0	7.8		
LD/LDP-90	1/15	1/6	1550*	92 W	CFM	819	735	714	654	608	562	485	361		
					Sones	8.8	8.6	8.5	8.4	8.3	8.1	7.8	7.9		
LD/LDP-95	1/8	1/6	1550*	160 W	CFM	1052	965	942	870	825	780	695	552	430	396
					Sones	11.8	11.2	11.1	10.8	10.4	10.2	10.0	9.8	10.1	10.2

Performance certified is for installation type A: Free inlet, Free outlet. Power rating (Bhp) does not include transmission losses. Performance ratings include the effects of a birdscreen in the airstream. \*Speed (RPM) shown is nominal. Performance is based on actual speed of test. The sound ratings shown are loudness values in fan sones at 5 feet (1.5 m) in a hemispherical free field calculated per AMCA Standard 301. Values shown are for installation type A: Free inlet hemispherical sones.



# LD/LDP 100-120

## Direct Drive VG



### LD Dimensions

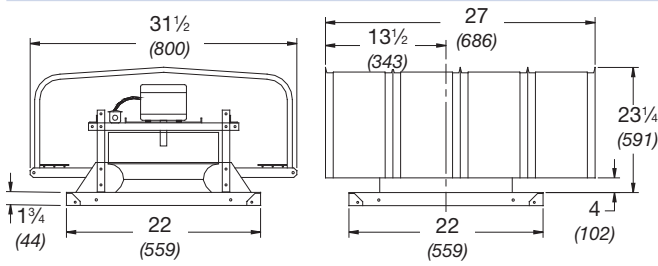

### LDP Dimensions

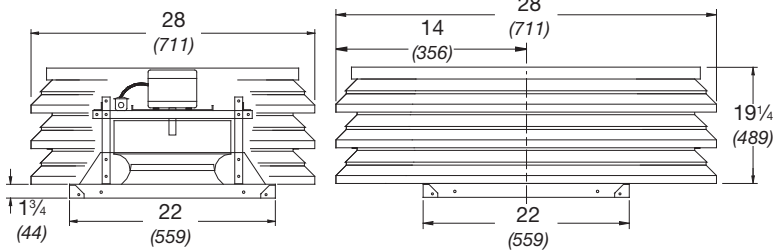

	LD 100 thru LD 120	LDP 100 thru LDP 120
Hood Thickness	24 ga	-
Cover Thickness	-	0.064 (0.029)
Louver Thickness	-	0.081 (0.036)
Curb Cap Thickness	0.064 (0.029)	0.064 (0.029)
Damper Size Square	12 (305)	12 (305)
Roof Opening Square	14 1/2 (368)	14 1/2 (368)
Weight*	Galvanized 57 (26)	Aluminum 82 (37)

All dimensions are in inches (millimeters). Weight in pounds (kilograms).

\*Weight shown is the largest cataloged Open Drip Proof motor.

See page 11 for severe duty LDP dimensions.

LD/LDP-100

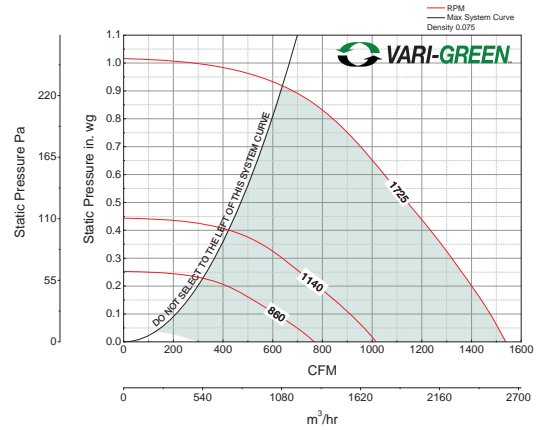

LD/LDP-120

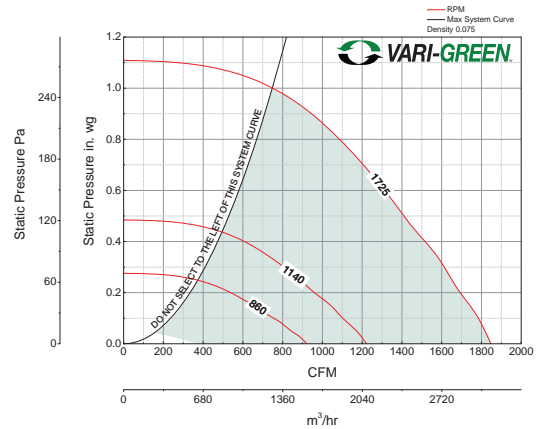

Model Number	Motor HP	VG HP	Fan RPM	CFM / Static Pressure in Inches wg											
				0	0.125	0.2	0.25	0.375	0.5	0.625	0.75	0.875	0.9		
LD/LDP-100-C	1/8	1/4	860	CFM	766	568	407								
				BHP	0.022	0.029	0.028								
				Sones	6.3	5.3	5.1								
LD/LDP-100-B	1/6	1/4	1140	CFM	1016	879	780	709	493						
				BHP	0.051	0.065	0.068	0.068	0.066						
				Sones	12.0	11.0	10.6	10.4	10.4						
LD/LDP-100-A	1/4	1/4	1725	CFM	1538	1457	1399	1360	1256	1142	1024	891	724	678	
				BHP	0.18	0.21	0.22	0.22	0.23	0.24	0.24	0.23	0.23	0.22	0.22
				Sones	16.2	14.8	14.4	14.2	14.3	14.2	14.8	15.3	15.9	16.1	
LD/LDP-120-C	1/8	1/4	860	CFM	921	702	536								
				BHP	0.03	0.041	0.043								
				Sones	6.6	5.3	5.1								
LD/LDP-120-B	1/6	1/4	1140	CFM	1221	1072	960	886	664						
				BHP	0.071	0.086	0.094	0.096	0.099						
				Sones	11.9	10.9	10.3	10.0	9.2						
LD/LDP-120-A	1/4	1/2	1725	CFM	1848	1762	1693	1652	1540	1412	1286	1142	979	940	
				BHP	0.25	0.28	0.29	0.29	0.31	0.33	0.34	0.35	0.34	0.33	
				Sones	21	19.6	19.4	19.3	18.6	18.4	18.2	18.2	18.3	18.3	

Performance certified is for installation type A: Free inlet, Free outlet. Power rating (Bhp) does not include transmission losses. Performance ratings include the effects of a birdscreen in the airstream. The sound ratings shown are loudness values in fan sones at 5 feet (1.5 m) in a hemispherical free field calculated per AMCA Standard 301. Values shown are for installation type A: Free inlet hemispherical sones.

# LB/LBP 10 Belt Drive



## LB Dimensions

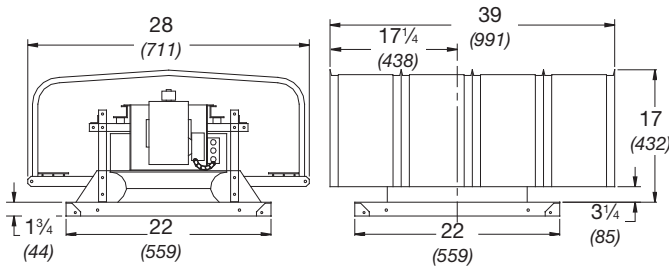

## LBP Dimensions

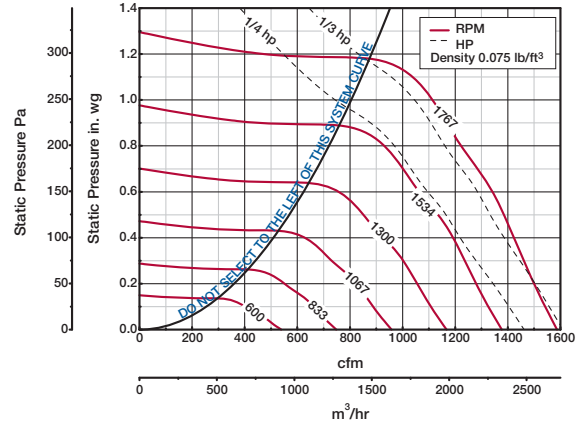
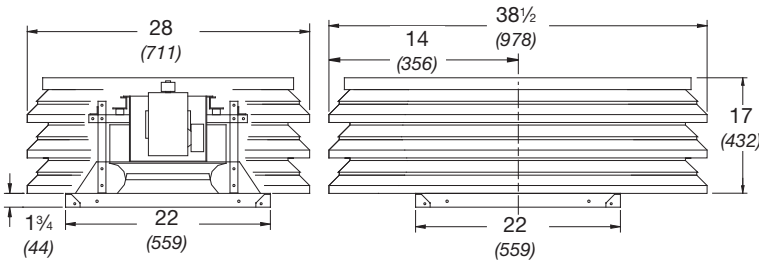

	LB-10	LBP-10
Hood Thickness	22 ga	-
Cover Thickness	-	0.064 (0.029)
Louver Thickness	-	0.081 (0.036)
Curb Cap Thickness	0.064 (0.029)	0.064 (0.029)
Damper Size Square	12 (305)	12 (305)
Roof Opening Square	14 1/2 (368)	14 1/2 (368)
Weight*	Galvanized 56 (25)	Aluminum 99 (45)

All dimensions are in inches (millimeters). Weight in pounds (kilograms).  
\*Weight shown is the largest cataloged Open Drip Proof motor.  
See page 11 for severe duty LBP dimensions.

Model Number	Motor HP	Fan RPM	CFM / Static Pressure in Inches wg																	
			0	0.125	0.25	0.375	0.5	0.625	0.75	0.875	1	1.125								
LB/LBP-10-4	1/4	600	CFM	539	351															
			BHP	0.013	0.014															
			Sones	3.0	1.6															
		712	CFM	639	500															
			BHP	0.021	0.024															
			Sones	3.6	2.3															
		937	CFM	841	746	623														
			BHP	0.048	0.053	0.054														
			Sones	5.1	4.3	3.6														
		1049	CFM	942	855	759	625													
			BHP	0.067	0.073	0.076	0.075													
			Sones	5.9	5.3	4.7	4.2													
		1162	CFM	1043	963	887	780	618												
			BHP	0.091	0.097	0.103	0.103	0.099												
			Sones	6.9	6.3	5.9	5.4	4.7												
		1274	CFM	1144	1070	1004	917	818												
			BHP	0.12	0.13	0.13	0.14	0.14												
			Sones	8.0	7.5	7.1	6.8	6.3												
1386	CFM	1244	1177	1114	1047	953	861													
	BHP	0.15	0.16	0.17	0.18	0.18	0.17													
	Sones	9.2	8.8	8.4	8.2	7.9	7.3													
1499	CFM	1346	1283	1224	1168	1093	1006	910												
	BHP	0.19	0.2	0.21	0.22	0.22	0.22	0.22												
	Sones	10.0	9.8	9.5	9.3	8.8	8.3	7.8												
1611	CFM	1446	1388	1331	1280	1220	1142	1064	970											
	BHP	0.24	0.25	0.26	0.27	0.28	0.28	0.28	0.27											
	Sones	11.2	10.9	10.7	10.4	10.1	9.5	9.0	8.5											
LB/LBP-10-3	1/3	1689	CFM	1516	1461	1406	1356	1304	1237	1158	1087	980								
			BHP	0.28	0.29	0.3	0.31	0.32	0.32	0.32	0.32	0.32	0.31							
			Sones	12.2	11.9	11.6	11.3	11.0	10.6	9.9	9.5	8.9								
		1767	CFM	1587	1533	1480	1432	1385	1327	1254	1182	1112	997							
			BHP	0.32	0.33	0.34	0.35	0.36	0.36	0.36	0.36	0.36	0.36	0.36						
			Sones	13.5	13.0	12.6	12.2	11.9	11.7	11.0	10.5	10.1	9.5							

MAX. BHP AT A GIVEN RPM - (rpm/2476)<sup>3</sup>  
 MAXIMUM FRPM = 1767  
 TIP SPEED = rpm x 2.913  
 MAX. MOTOR FRAME SIZE = 56

Performance certified is for installation type A: Free inlet, Free outlet. Power rating (Bhp) does not include transmission losses. Performance ratings include the effects of a birdscreen in the airstream. The sound ratings shown are loudness values in fan sones at 5 feet (1.5 m) in a hemispherical free field calculated per AMCA Standard 301. Values shown are for installation type A: Free inlet hemispherical sones.

# LB/LBP 14 Belt Drive



## LB Dimensions

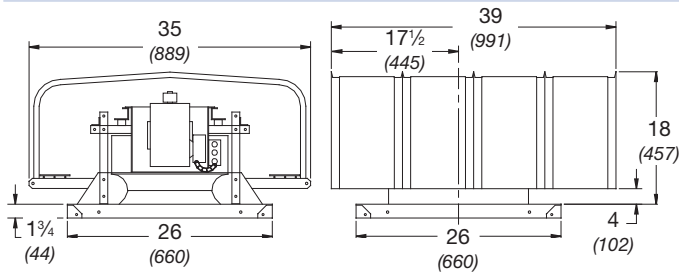

## LBP Dimensions

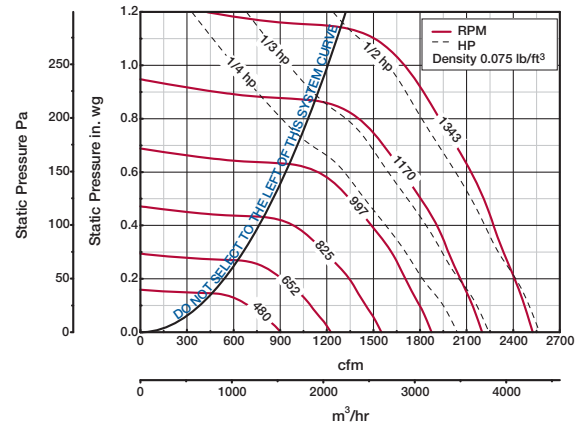
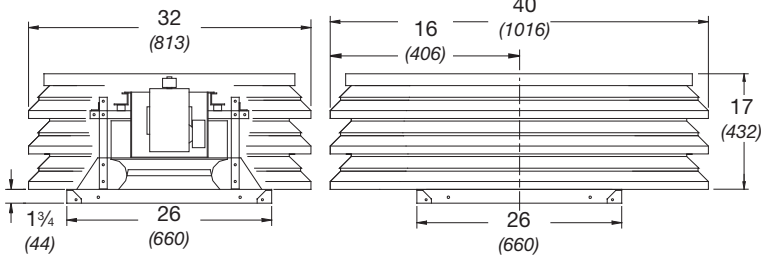

	LB-14	LBP-14
Hood Thickness	22 ga	-
Cover Thickness	-	0.064 (0.029)
Louver Thickness	-	0.081 (0.036)
Curb Cap Thickness	0.064 (0.029)	0.064 (0.029)
Damper Size Square	16 (406)	16 (406)
Roof Opening Square	18 1/2 (470)	18 1/2 (470)
Weight*	Galvanized 81 (37)	Aluminum 116 (53)

All dimensions are in inches (millimeters). Weight in pounds (kilograms).  
\*Weight shown is the largest cataloged Open Drip Proof motor.  
See page 11 for severe duty LBP dimensions.

Model Number	Motor HP	Fan RPM		CFM / Static Pressure in Inches wg												
				0	0.125	0.25	0.375	0.5	0.625	0.75	0.875	1	1.125			
LB/LBP-14-4	1/4	480	CFM	903	614											
			BHP	0.022	0.025											
			Sones	4.1	3.2											
		564	CFM	1061	848											
			BHP	0.035	0.041											
			Sones	4.7	4.2											
		731	CFM	1375	1231	1024										
			BHP	0.077	0.086	0.089										
			Sones	5.9	5.6	5.1										
		815	CFM	1533	1402	1241	1013									
			BHP	0.11	0.12	0.12	0.12									
			Sones	6.7	6.4	5.9	5.4									
899	CFM	1690	1574	1439	1264	946										
	BHP	0.14	0.15	0.16	0.17	0.15										
	Sones	7.5	7.3	6.9	6.4	5.7										
982	CFM	1847	1743	1629	1482	1297										
	BHP	0.19	0.2	0.21	0.21	0.21										
	Sones	8.5	8.4	8	7.5	7										
1066	CFM	2004	1912	1807	1681	1534	1351									
	BHP	0.24	0.25	0.26	0.27	0.28	0.27									
	Sones	9.8	9.7	9.4	8.9	8.4	7.8									
LB/LBP-14-3	1/3	1118	CFM	2102	2016	1913	1801	1672	1512	1257						
			BHP	0.27	0.28	0.3	0.31	0.32	0.32	0.3						
			Sones	10.7	10.6	10.3	9.8	9.3	8.7	8.1						
		1170	CFM	2200	2120	2019	1920	1797	1657	1487						
			BHP	0.31	0.32	0.34	0.36	0.36	0.36	0.36						
			Sones	11.5	11.3	11.1	10.6	10.1	9.5	9.0						
LB/LBP-14-5	1/2	1257	CFM	2364	2290	2197	2112	2002	1887	1748	1585					
			BHP	0.39	0.4	0.42	0.44	0.44	0.45	0.45	0.44					
			Sones	12.9	12.7	12.5	12.1	11.6	11.1	10.5	10.1					
		1343	CFM	2525	2456	2372	2289	2199	2092	1979	1848	1692	1386			
			BHP	0.47	0.49	0.51	0.53	0.54	0.55	0.55	0.55	0.55	0.54	0.51		
			Sones	14.4	14.1	13.8	13.5	13.1	12.6	12.2	11.6	11.1	10.4			

MAX. BHP AT A GIVEN RPM - (rpm/1639)<sup>3</sup>  
 MAXIMUM FRPM = 1343  
 TIP SPEED = rpm x 3.829  
 MAX. MOTOR FRAME SIZE = 56

Performance certified is for installation type A: Free inlet, Free outlet. Power rating (Bhp) does not include transmission losses. Performance ratings include the effects of a birdscreen in the airstream. The sound ratings shown are loudness values in fan sones at 5 feet (1.5 m) in a hemispherical free field calculated per AMCA Standard 301. Values shown are for installation type A: Free inlet hemispherical sones.



# LB/LBP 18 Belt Drive



## LB Dimensions

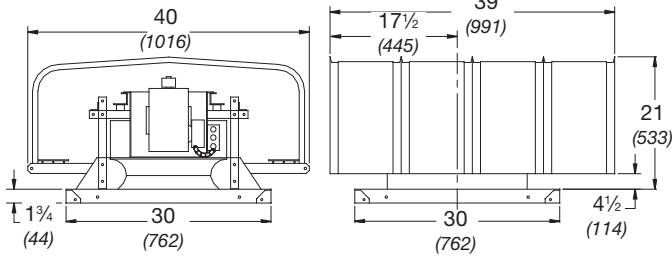

## LBP Dimensions

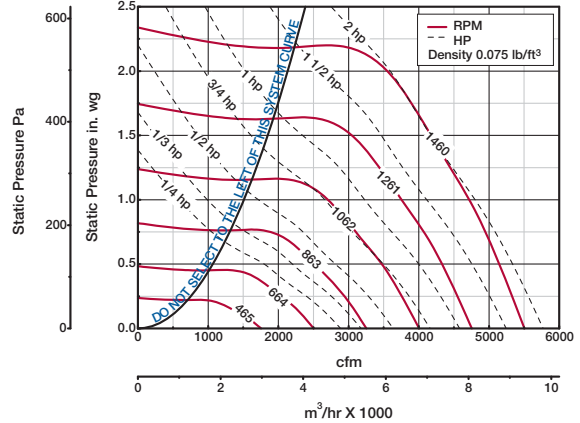
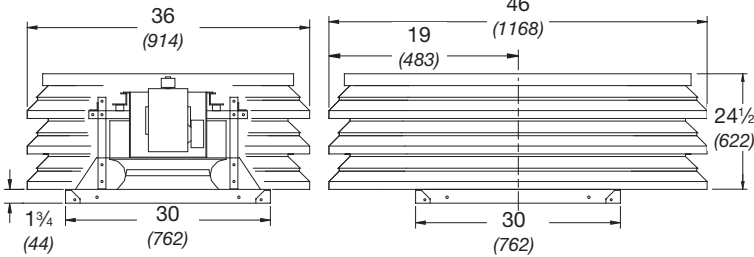

	LB-18	LBP-18
Hood Thickness	22 ga	-
Cover Thickness	-	0.064 (0.029)
Louver Thickness	-	0.081 (0.036)
Curb Cap Thickness	0.064 (0.029)	0.064 (0.029)
Damper Size Square	18 (457)	18 (457)
Roof Opening Square	20 1/2 (521)	20 1/2 (521)
Weight*	Galvanized 135 (61)	Aluminum 179 (81)

All dimensions are in inches (millimeters). Weight in pounds (kilograms).  
\*Weight shown is the largest cataloged Open Drip Proof motor.  
See page 11 for severe duty LBP dimensions.

Model Number	Motor HP	Fan RPM	CFM / Static Pressure in Inches wg														
			0	0.125	0.25	0.5	0.75	1	1.25	1.5	1.75	2					
LB/LBP-18-4	1/4	465	CFM	1753	1422												
			BHP	0.056	0.064												
			Sones	3.6	2.7												
		562	CFM	2119	1871	1522											
			BHP	0.099	0.108	0.114											
			Sones	4.9	4.1	3.4											
755	CFM	2847	2671	2474	1925												
	BHP	0.24	0.25	0.27	0.27												
	Sones	8.7	7.9	7.4	6.5												
LB/LBP-18-3	1/3	826	CFM	3115	2957	2778	2324										
			BHP	0.31	0.33	0.34	0.36										
			Sones	10.2	9.5	8.9	8.0										
LB/LBP-18-5	1/2	888	CFM	3348	3203	3039	2638	2110									
			BHP	0.39	0.4	0.42	0.45	0.44									
			Sones	11.7	11.0	10.4	9.4	8.7									
		949	CFM	3578	3442	3292	2936	2498									
			BHP	0.48	0.49	0.51	0.54	0.55									
			Sones	13.4	13.0	12.0	11.0	10.3									
LB/LBP-18-7	3/4	1085	CFM	4091	3972	3847	3575	3218	2822								
			BHP	0.71	0.73	0.75	0.79	0.82	0.82								
			Sones	16.8	16.2	15.5	14.6	13.4	12.9								
LB/LBP-18-10	1	1141	CFM	4302	4189	4073	3814	3493	3140	2674							
			BHP	0.83	0.84	0.86	0.91	0.94	0.96	0.93							
			Sones	18.0	17.3	16.7	15.9	14.8	14.1	13.8							
LB/LBP-18-15	1 1/2	1286	CFM	4849	4749	4648	4423	4183	3880	3568	3208						
			BHP	1.19	1.2	1.22	1.27	1.32	1.35	1.37	1.35						
			Sones	21	20	19.8	19.2	18.5	17.8	17.4	17.1						
		1375	CFM	5185	5091	4997	4790	4576	4311	4025	3719	3382					
			BHP	1.45	1.47	1.49	1.54	1.59	1.63	1.66	1.67	1.65					
			Sones	24	23	22	21	21	20	19.9	19.6	19.5					
LB/LBP-18-20	2	1460	CFM	5505	5417	5328	5138	4936	4714	4446	4176	3874	3538				
			BHP	1.73	1.76	1.78	1.83	1.88	1.93	1.98	2	2	1.97				
			Sones	26	25	24	23	23	22	22	22	22	22	22			

Performance certified is for installation type A: Free inlet, Free outlet. Power rating (Bhp) does not include transmission losses. Performance ratings include the effects of a birdscreen in the airstream. The sound ratings shown are loudness values in fan sones at 5 feet (1.5 m) in a hemispherical free field calculated per AMCA Standard 301. Values shown are for installation type A: Free inlet hemispherical sones.

# LB/LBP 21 Belt Drive



## LB Dimensions

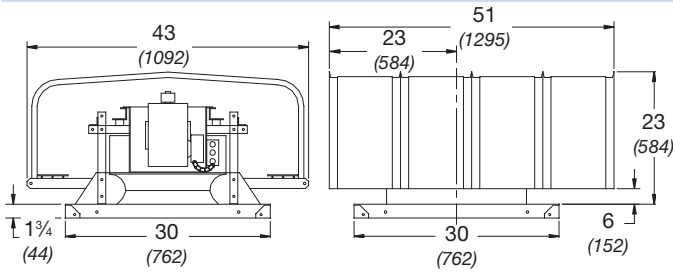

## LBP Dimensions

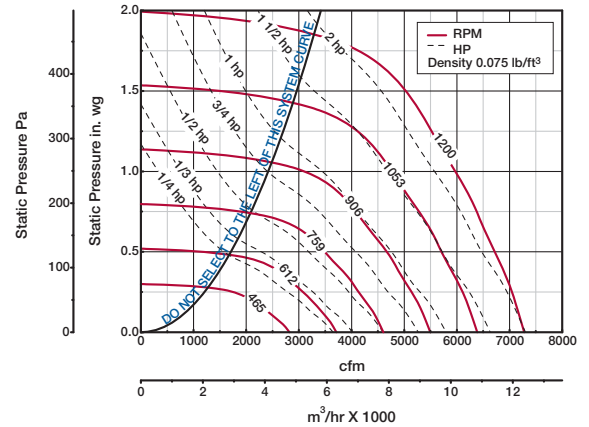
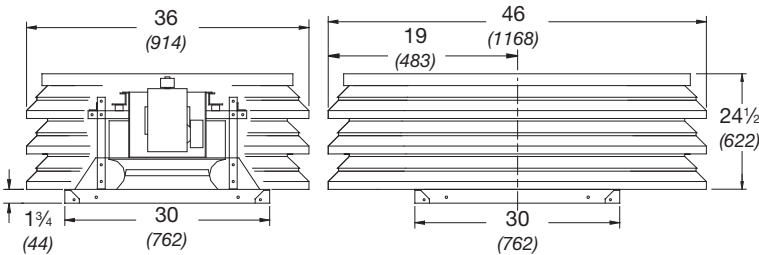

	LB-21	LBP-21
Hood Thickness	22 ga	-
Cover Thickness	-	0.064 (0.029)
Louver Thickness	-	0.081 (0.036)
Curb Cap Thickness	0.064 (0.029)	0.064 (0.029)
Damper Size Square	18 (457)	18 (457)
Roof Opening Square	20 1/2 (521)	20 1/2 (521)
Weight*	Galvanized 145 (66)	Aluminum 191 (86)

All dimensions are in inches (millimeters). Weight in pounds (kilograms).  
\*Weight shown is the largest cataloged Open Drip Proof motor.  
See page 11 for severe duty LBP dimensions.

Model Number	Motor HP	Fan RPM		CFM / Static Pressure in Inches wg											
				0	0.25	0.375	0.5	0.625	0.75	1	1.25	1.5	1.75		
LB/LBP-21-4	1/4	465	CFM	2820	1732										
			BHP	0.12	0.13										
			Sones	6.6	5.2										
		595	CFM	3609	2938	2457									
			BHP	0.24	0.28	0.28									
			Sones	8.8	7.8	6.9									
LB/LBP-21-3	1/3	651	CFM	3948	3371	2970	2354								
			BHP	0.32	0.36	0.36	0.34								
			Sones	10.1	8.8	8.2	6.9								
LB/LBP-21-5	1/2	699	CFM	4239	3724	3362	2954	1964							
			BHP	0.39	0.44	0.45	0.45	0.38							
			Sones	11.6	9.9	9.3	8.6	7.1							
		747	CFM	4531	4056	3741	3390	2909							
			BHP	0.48	0.53	0.54	0.55	0.53							
			Sones	13.4	11.2	10.4	9.8	9.1							
LB/LBP-21-7	3/4	801	CFM	4858	4424	4157	3833	3491	2937						
			BHP	0.59	0.65	0.66	0.67	0.68	0.64						
			Sones	15.5	12.9	11.8	11.3	10.8	10.1						
		855	CFM	5186	4790	4553	4261	3954	3608						
			BHP	0.72	0.79	0.8	0.81	0.82	0.82						
			Sones	16.7	14.4	13.3	12.8	12.1	11.5						
LB/LBP-21-10	1	899	CFM	5452	5087	4858	4602	4313	4019	2894					
			BHP	0.83	0.91	0.93	0.94	0.95	0.96	0.86					
			Sones	17.1	15.4	14.5	13.9	13.4	12.7	11.7					
LB/LBP-21-15	1 1/2	1010	CFM	6126	5826	5614	5415	5183	4926	4386	3369				
			BHP	1.18	1.26	1.3	1.32	1.34	1.35	1.36	1.24				
			Sones	20	18.9	18.1	17.3	16.6	16.2	15.0	14.0				
		1077	CFM	6532	6260	6068	5877	5691	5451	4965	4395				
			BHP	1.43	1.52	1.56	1.59	1.61	1.62	1.65	1.63				
			Sones	22	21	20	19.4	18.8	18.2	17.3	16.4				
LB/LBP-21-20	2	1200	CFM	7278	7034	6890	6712	6542	6375	5954	5517	5013	4122		
			BHP	1.98	2.07	2.12	2.18	2.2	2.22	2.25	2.28	2.26	2.11		
			Sones	26	25	25	24	23	23	22	21	20	18.5		

MAX. BHP AT A GIVEN RPM - (rpm/910)<sup>3</sup>  
MAXIMUM FRPM = 1200  
TIP SPEED = rpm x 5.596  
MAX. MOTOR FRAME SIZE = 145T

Performance certified is for installation type A: Free inlet, Free outlet. Power rating (Bhp) does not include transmission losses. Performance ratings include the effects of a birdscreen in the airstream. The sound ratings shown are loudness values in fan sones at 5 feet (1.5 m) in a hemispherical free field calculated per AMCA Standard 301. Values shown are for installation type A: Free inlet hemispherical sones.

# LB/LBP 24 Belt Drive



## LB Dimensions

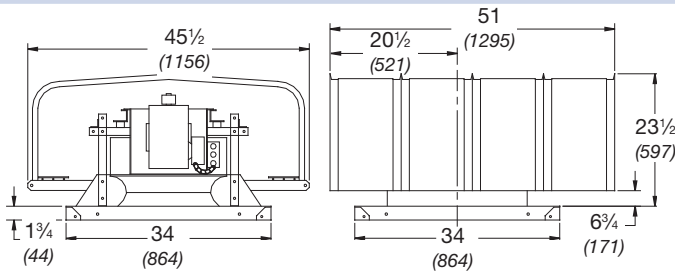

## LBP Dimensions

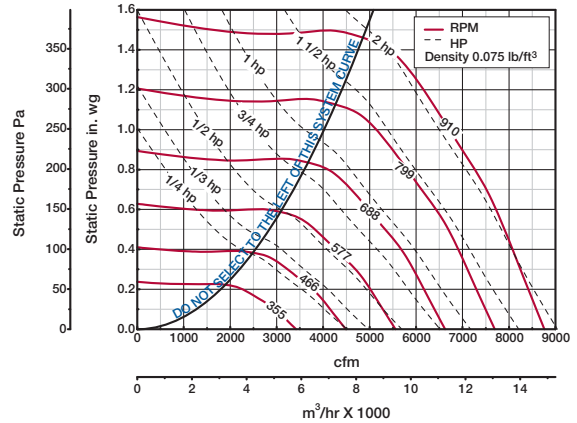
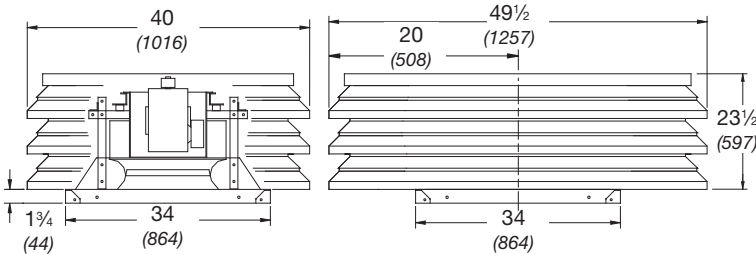

	LB-24	LBP-24
Hood Thickness	22 ga	-
Cover Thickness	-	0.064 (0.029)
Louver Thickness	-	0.081 (0.036)
Curb Cap Thickness	0.064 (0.029)	0.064 (0.029)
Damper Size Square	24 (610)	24 (610)
Roof Opening Square	26 1/2 (673)	26 1/2 (673)
Weight*	Galvanized 188 (85)	Aluminum 239 (108)

All dimensions are in inches (millimeters). Weight in pounds (kilograms).  
\*Weight shown is the largest cataloged Open Drip Proof motor.  
See page 11 for severe duty LBP dimensions.

Model Number	Motor HP	Fan RPM	CFM / Static Pressure in Inches wg														
			0	0.25	0.375	0.5	0.625	0.75	0.875	1	1.25	1.375					
LB/LBP-24-4	1/4	355	CFM	3419													
			BHP	0.11													
			Sones	5.8													
		409	CFM	3938	2715												
			BHP	0.17	0.19												
			Sones	6.3	5.1												
462	CFM	4449	3451	2491													
	BHP	0.24	0.28	0.25													
	Sones	7.4	6.3	5.3													
LB/LBP-24-3	1/3	508	CFM	4892	4043	3433											
			BHP	0.32	0.36	0.36											
			Sones	8.5	7.4	6.8											
LB/LBP-24-5	1/2	582	CFM	5604	4917	4441	3899										
			BHP	0.48	0.54	0.55	0.55										
			Sones	10.7	9.4	8.9	8.4										
LB/LBP-24-7	3/4	625	CFM	6018	5381	4988	4497	3929									
			BHP	0.59	0.66	0.68	0.68	0.66									
			Sones	12.4	11.0	10.3	10.0	9.5									
		667	CFM	6423	5828	5505	5062	4589	3984								
			BHP	0.72	0.8	0.82	0.83	0.83	0.79								
			Sones	14.1	12.7	12.0	11.5	11.1	10.9								
LB/LBP-24-10	1	734	CFM	7068	6531	6252	5912	5503	5073	4555							
			BHP	0.96	1.05	1.08	1.1	1.1	1.1	1.07							
			Sones	17.0	15.3	14.6	13.9	13.5	13.2	12.9							
LB/LBP-24-15	1 1/2	787	CFM	7578	7080	6820	6560	6190	5799	5398	4909						
			BHP	1.18	1.29	1.32	1.35	1.36	1.36	1.36	1.32						
			Sones	19.6	17.4	16.5	15.9	15.4	15.0	14.8	14.1						
LB/LBP-24-20	2	868	CFM	8358	7907	7675	7440	7192	6855	6505	6141	5285					
			BHP	1.58	1.7	1.74	1.78	1.81	1.82	1.83	1.82	1.76	1.76				
			Sones	24	21	20	19.4	18.9	18.3	17.9	17.6	16.0					
		910	CFM	8763	8333	8114	7889	7664	7377	7056	6713	5995	5537				
			BHP	1.82	1.95	2	2.04	2.07	2.09	2.1	2.1	2.08	2.03				
			Sones	27	24	23	21	21	20	19.8	19.5	18.4	17.2				

Performance certified is for installation type A: Free inlet, Free outlet. Power rating (Bhp) does not include transmission losses. Performance ratings include the effects of a birdscreen in the airstream. The sound ratings shown are loudness values in fan sones at 5 feet (1.5 m) in a hemispherical free field calculated per AMCA Standard 301. Values shown are for installation type A: Free inlet hemispherical sones.

# LB/LBP 30 Belt Drive



## LB Dimensions

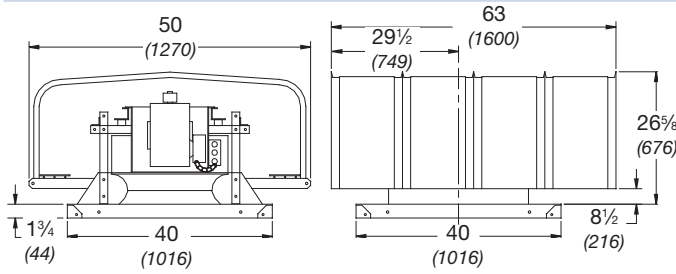

## LBP Dimensions

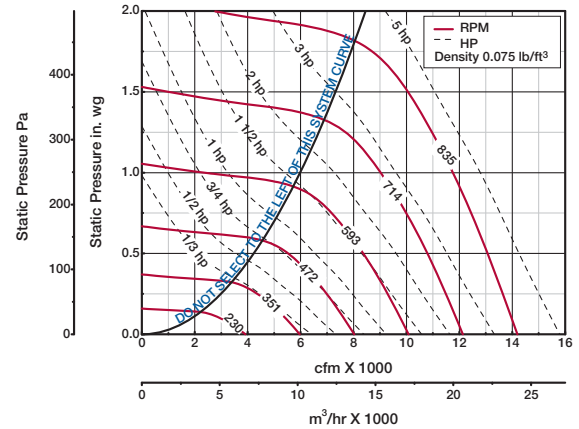
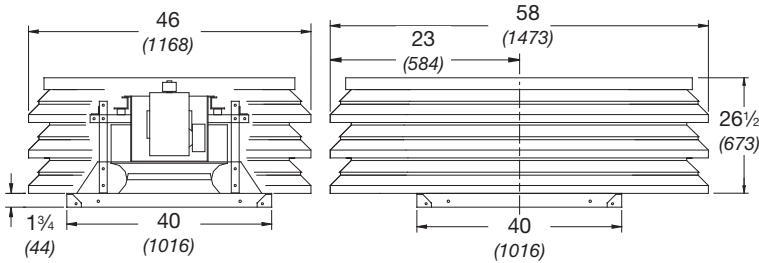

	LB-30	LBP-30
Hood Thickness	22 ga	-
Cover Thickness	-	0.064 (0.029)
Louver Thickness	-	0.081 (0.036)
Curb Cap Thickness	0.064 (0.029)	0.064 (0.029)
Damper Size Square	30 (762)	30 (762)
Roof Opening Square	32 1/2 (826)	32 1/2 (826)
Weight*	Galvanized 249 (113)	Aluminum 318 (144)

All dimensions are in inches (millimeters). Weight in pounds (kilograms).  
\*Weight shown is the largest cataloged Open Drip Proof motor.  
See page 11 for severe duty LBP dimensions.

Model Number	Motor HP	Fan RPM	CFM / Static Pressure in Inches wg													
			0	0.25	0.375	0.5	0.625	0.75	1	1.25	1.5	1.75				
LB/LBP-30-3	1/3	230	CFM	3910												
			BHP	0.076												
			Sones	8.0												
		366	CFM	6221	4729											
			BHP	0.31	0.37											
			Sones	8.7	5.9											
LB/LBP-30-5	1/2	394	CFM	6697	5354	4290										
			BHP	0.38	0.45	0.44										
			Sones	9.0	6.5	6.0										
		421	CFM	7156	5939	5076										
			BHP	0.47	0.54	0.55										
			Sones	9.7	7.4	6.7										
LB/LBP-30-7	3/4	483	CFM	8210	7196	6567	5777									
			BHP	0.7	0.8	0.83	0.83									
			Sones	12.0	10.7	9.7	8.8									
LB/LBP-30-10	1	529	CFM	8992	8079	7559	6946	6162								
			BHP	0.92	1.04	1.07	1.1	1.09								
			Sones	13.8	12.9	12.1	11.4	10.3								
		567	CFM	9638	8797	8334	7786	7174	6410							
			BHP	1.14	1.27	1.31	1.34	1.36	1.33							
			Sones	15.3	14.2	13.6	13.0	12.3	11.2							
LB/LBP-30-15	1 1/2	605	CFM	10284	9507	9073	8605	8068	7434							
			BHP	1.38	1.53	1.57	1.61	1.64	1.64							
			Sones	16.8	15.7	15.2	14.6	14.1	13.3							
LB/LBP-30-20	2	667	CFM	11338	10639	10257	9863	9419	8933	7737						
			BHP	1.85	2.02	2.07	2.12	2.16	2.19	2.17						
			Sones	19.8	18.6	17.9	17.5	17.1	16.6	14.9						
LB/LBP-30-30	3	703	CFM	11950	11287	10935	10562	10184	9722	8701	7032					
			BHP	2.17	2.34	2.41	2.46	2.51	2.54	2.57	2.41					
			Sones	22	20	19.5	19.1	18.7	18.3	17.0	14.2					
LB/LBP-30-50	5	835	CFM	14194	13635	13356	13062	12747	12432	11728	10951	9965	8478			
			BHP	3.63	3.84	3.95	4.03	4.09	4.14	4.24	4.33	4.29	4.06			
			Sones	27	26	25	25	24	24	23	22	21	18.2			

MAX. BHP AT A GIVEN RPM - (rpm/512)<sup>3</sup>  
MAXIMUM FRPM = 835  
TIP SPEED = rpm x 7.985  
MAX. MOTOR FRAME SIZE = 184T

Performance certified is for installation type A: Free inlet, Free outlet. Power rating (Bhp) does not include transmission losses. Performance ratings include the effects of a birdscreen in the airstream. The sound ratings shown are loudness values in fan sones at 5 feet (1.5 m) in a hemispherical free field calculated per AMCA Standard 301. Values shown are for installation type A: Free inlet hemispherical sones.



# LB/LBP 36 Belt Drive



## LB Dimensions

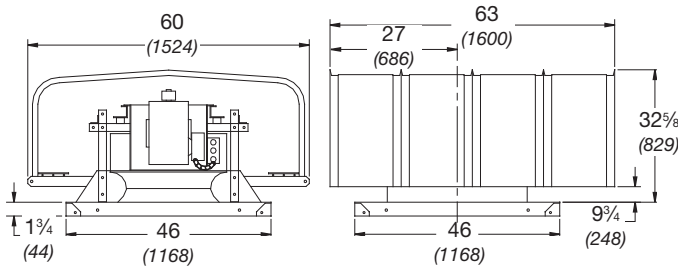

## LBP Dimensions

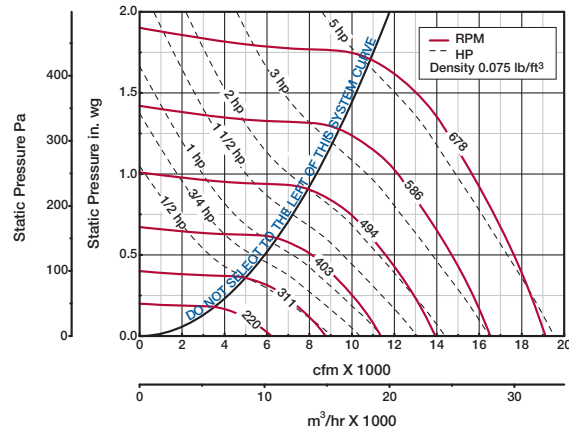
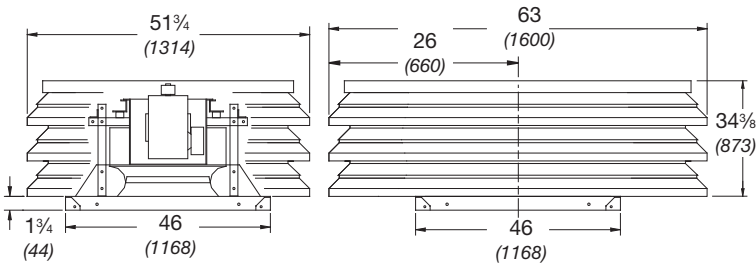

	LB-36	LBP-36
Hood Thickness	0.064 (0.029)	-
Cover Thickness	-	0.064 (0.029)
Louver Thickness	-	0.081 (0.036)
Curb Cap Thickness	0.064 (0.029)	0.064 (0.029)
Damper Size Square	36 (914)	36 (914)
Roof Opening Square	38 1/2 (978)	38 1/2 (978)
Weight*	Galvanized 338 (153)	Aluminum 444 (201)

All dimensions are in inches (millimeters). Weight in pounds (kilograms).  
\*Weight shown is the largest cataloged Open Drip Proof motor.  
See page 11 for severe duty LBP dimensions.

Model Number	Motor HP	Fan RPM	CFM / Static Pressure in Inches wg																
			0	0.25	0.375	0.5	0.625	0.75	0.875	1	1.25	1.5							
LB/LBP-36-5	1/2	220	CFM	6204															
			BHP	0.16															
			Sones	4.9															
		315	CFM	8884	6937														
			BHP	0.47	0.55														
			Sones	8.2	6.3														
LB/LBP-36-7	3/4	360	CFM	10153	8570	7487													
			BHP	0.7	0.81	0.83													
			Sones	10.6	8.9	7.9													
LB/LBP-36-10	1	397	CFM	11196	9816	8911	7775												
			BHP	0.94	1.08	1.1	1.1												
			Sones	13.7	12.1	10.6	9.4												
LB/LBP-36-15	1 1/2	426	CFM	12014	10765	9964	9056	7716											
			BHP	1.16	1.32	1.35	1.37	1.34											
			Sones	14.8	14.0	12.7	11.6	10.1											
		454	CFM	12804	11668	10949	10127	9209	7552										
			BHP	1.41	1.58	1.63	1.65	1.66	1.57										
			Sones	16.0	15.4	14.5	13.7	12.5	11.0										
LB/LBP-36-20	2	499	CFM	14073	13064	12442	11760	11004	10173	8773									
			BHP	1.87	2.06	2.13	2.17	2.2	2.2	2.12									
			Sones	18.2	17.6	17.2	16.6	16.1	15.1	13.9									
LB/LBP-36-30	3	536	CFM	15116	14196	13646	13037	12361	11652	10837	9559								
			BHP	2.31	2.52	2.61	2.67	2.7	2.73	2.72	2.65								
			Sones	20	19.7	19.3	18.7	18.4	17.8	16.7	15.8								
		572	CFM	16132	15287	14790	14229	13649	12989	12313	11534								
			BHP	2.81	3.04	3.14	3.21	3.26	3.29	3.32	3.31								
			Sones	22	22	21	21	20	19.9	19.0	18.1								
LB/LBP-36-50	5	614	CFM	17316	16540	16087	15598	15066	14504	13890	13262	11584							
			BHP	3.48	3.72	3.84	3.93	3.99	4.05	4.08	4.1	4.04							
			Sones	25	24	24	24	23	23	22	21	19.2							
		678	CFM	19121	18419	18041	17621	17165	16683	16192	15636	14494	12970						
			BHP	4.69	4.95	5.08	5.21	5.3	5.37	5.44	5.47	5.52	5.45						
			Sones	30	29	29	29	28	27	27	26	24	22						

MAX. BHP AT A GIVEN RPM - (rpm/384)<sup>3</sup>  
 MAXIMUM FRPM = 678  
 TIP SPEED = rpm x 9.425  
 MAX. MOTOR FRAME SIZE = 184T

Performance certified is for installation type A: Free inlet, Free outlet. Power rating (Bhp) does not include transmission losses. Performance ratings include the effects of a birdscreen in the airstream. The sound ratings shown are loudness values in fan sones at 5 feet (1.5 m) in a hemispherical free field calculated per AMCA Standard 301. Values shown are for installation type A: Free inlet hemispherical sones.

# LB/LBP 42 Belt Drive



## LB Dimensions

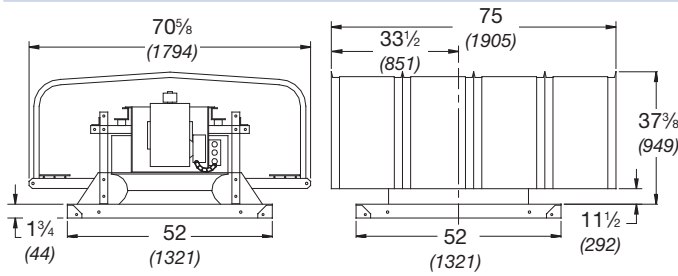

## LBP Dimensions

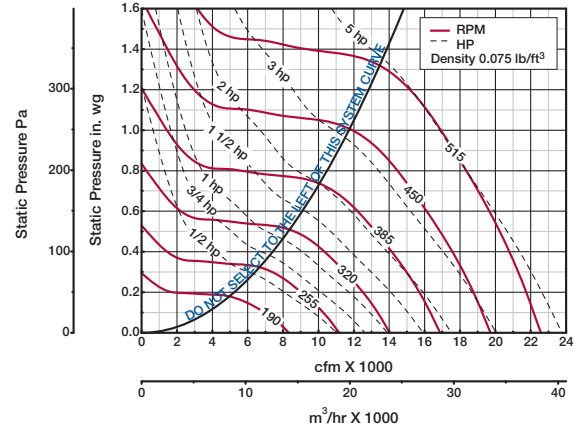
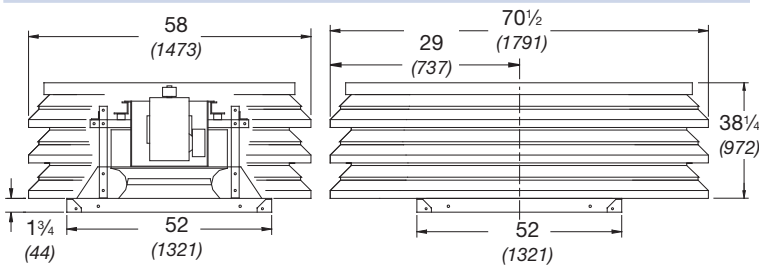

	LB-42	LBP-42
Hood Thickness	0.064 (0.029)	-
Cover Thickness	-	0.064 (0.029)
Louver Thickness	-	0.081 (0.036)
Curb Cap Thickness	0.064 (0.029)	0.064 (0.029)
Damper Size Square	42 (1067)	42 (1067)
Roof Opening Square	44 1/2 (1130)	44 1/2 (1130)
Weight*	Galvanized 396 (180)	Aluminum 530 (240)

All dimensions are in inches (millimeters). Weight in pounds (kilograms).  
\*Weight shown is the largest cataloged Open Drip Proof motor.  
See page 11 for severe duty LBP dimensions.

Model Number	Motor HP	Fan RPM		CFM / Static Pressure in Inches wg											
				0	0.125	0.25	0.375	0.5	0.625	0.75	0.875	1	1.25		
LB/LBP-42-5	1/2	190	CFM	8328	6455										
			BHP	0.21	0.25										
			Sones	5.2	4.3										
		247	CFM	10827	9583	7772									
			BHP	0.47	0.53	0.55									
			Sones	6.9	6.0	5.5									
LB/LBP-42-7	3/4	283	CFM	12405	11362	9965	7932								
			BHP	0.71	0.78	0.83	0.81								
			Sones	8.3	7.6	7.1	6.5								
LB/LBP-42-10	1	311	CFM	13632	12718	11521	10057								
			BHP	0.94	1.02	1.08	1.1								
			Sones	9.8	9.3	8.7	8.3								
LB/LBP-42-15	1 1/2	334	CFM	14640	13812	12766	11480	9795							
			BHP	1.17	1.25	1.33	1.37	1.35							
			Sones	11.5	11.0	10.4	9.8	9.2							
		356	CFM	15605	14828	13887	12733	11417	9401						
			BHP	1.41	1.5	1.58	1.64	1.66	1.59						
			Sones	13.2	12.7	12.1	11.5	10.8	10.3						
LB/LBP-42-20	2	392	CFM	17183	16477	15667	14715	13626	12382	10481					
			BHP	1.89	1.98	2.08	2.16	2.21	2.21	2.13					
			Sones	16.1	15.5	14.9	14.3	13.7	13.2	12.9					
LB/LBP-42-30	3	420	CFM	18410	17751	17030	16205	15201	14135	12945	11013				
			BHP	2.32	2.42	2.52	2.62	2.68	2.72	2.72	2.61				
			Sones	18.6	18.0	17.3	16.6	16.1	15.4	15.3	15.2				
		448	CFM	19637	19020	18378	17605	16740	15786	14735	13494				
			BHP	2.82	2.93	3.04	3.14	3.22	3.28	3.3	3.28				
			Sones	22	21	20	19.4	18.8	18.1	17.5	17.6				
LB/LBP-42-50	5	482	CFM	21128	20554	19980	19281	18562	17683	16796	15798	14692			
			BHP	3.51	3.63	3.74	3.86	3.97	4.04	4.1	4.11	4.09			
			Sones	23	23	22	22	21	20	19.3	18.7	18.5			
		515	CFM	22574	22037	21500	20887	20214	19480	18651	17822	16871	14331		
			BHP	4.28	4.41	4.53	4.65	4.77	4.87	4.94	5.01	5.01	4.88		
			Sones	25	24	24	24	23	22	21	21	20	19.3		

MAX. BHP AT A GIVEN RPM - (rpm/301)<sup>3</sup>  
 MAXIMUM FRPM = 515  
 TIP SPEED = rpm x 11.061  
 MAX. MOTOR FRAME SIZE = 184T

Performance certified is for installation type A: Free inlet, Free outlet. Power rating (Bhp) does not include transmission losses. Performance ratings include the effects of a birdscreen in the airstream. The sound ratings shown are loudness values in fan sones at 5 feet (1.5 m) in a hemispherical free field calculated per AMCA Standard 301. Values shown are for installation type A: Free inlet hemispherical sones.

# LB/LBP 48 Belt Drive



## LB Dimensions

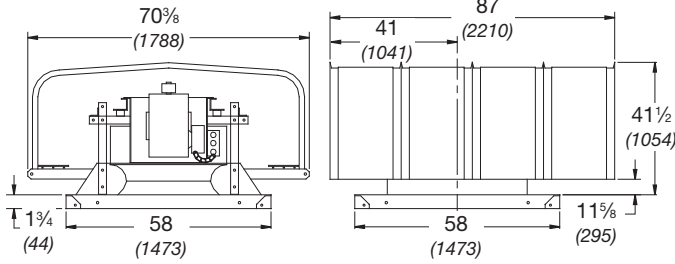

## LBP Dimensions

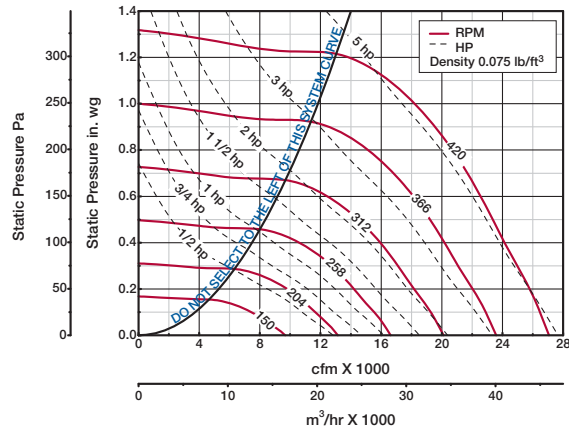
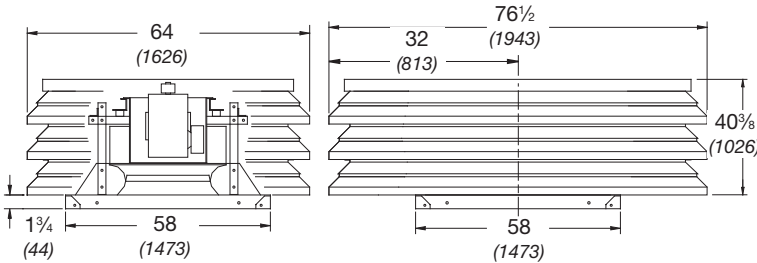

	LB-48	LBP-48
Hood Thickness	0.064 (0.029)	-
Cover Thickness	-	0.064 (0.029)
Louver Thickness	-	0.081 (0.036)
Curb Cap Thickness	0.064 (0.029)	0.064 (0.029)
Damper Size Square	48 (1219)	48 (1219)
Roof Opening Square	50 1/2 (1283)	50 1/2 (1283)
Weight*	Galvanized 430 (195)	Aluminum 579 (263)

All dimensions are in inches (millimeters). Weight in pounds (kilograms).  
\*Weight shown is the largest cataloged Open Drip Proof motor.  
See page 11 for severe duty LBP dimensions.

Model Number	Motor HP	Fan RPM	CFM / Static Pressure in Inches wg												
			0	0.125	0.25	0.375	0.5	0.625	0.75	0.875	0.9	1			
LB/LBP-48-5	1/2	150	CFM	9666	6546										
			BHP	0.21	0.24										
			Sones	6.1	5.4										
		175	CFM	11277	8948										
			BHP	0.34	0.38										
			Sones	6.9	5.6										
199	CFM	12824	10846	7629											
	BHP	0.5	0.56	0.54											
	Sones	7.6	6.8	7.0											
LB/LBP-48-7	3/4	226	CFM	14563	12863	10741									
			BHP	0.73	0.81	0.83									
			Sones	8.5	8.2	7.5									
LB/LBP-48-10	1	249	CFM	16046	14530	12787	10092								
			BHP	0.98	1.07	1.1	1.08								
			Sones	9.5	9.4	9.2	8.3								
LB/LBP-48-15	1 1/2	267	CFM	17205	15823	14222	12151								
			BHP	1.2	1.31	1.35	1.36								
			Sones	10.6	10.4	10.2	9.2								
		285	CFM	18365	17103	15612	13896	11357							
			BHP	1.46	1.58	1.63	1.66	1.61							
			Sones	12.3	11.7	11.1	10.5	9.6							
LB/LBP-48-20	2	314	CFM	20234	19141	17779	16397	14665	11934						
			BHP	1.96	2.1	2.17	2.2	2.22	2.1						
			Sones	15.4	14.5	13.4	12.5	12.2	11.5						
LB/LBP-48-30	3	359	CFM	23134	22214	21041	19878	18650	17134	15069	11596				
			BHP	2.93	3.1	3.21	3.25	3.29	3.31	3.25	2.84				
			Sones	18.4	17.8	17.2	16.5	15.9	15.5	14.8	13.4				
LB/LBP-48-50	5	381	CFM	24552	23685	22620	21512	20378	19104	17564	15491	15076			
			BHP	3.5	3.68	3.81	3.87	3.92	3.95	3.95	3.86	3.85			
			Sones	20	19.6	19.1	18.6	17.9	17.4	17.1	16.2	16.0			
		420	CFM	27065	26278	25383	24354	23363	22317	21159	19839	19534	18029		
			BHP	4.69	4.89	5.05	5.15	5.21	5.25	5.29	5.31	5.3	5.23		
			Sones	23	23	23	23	22	22	21	21	21	20		

MAX. BHP AT A GIVEN RPM - (rpm/241)<sup>3</sup>  
 MAXIMUM FRPM = 420  
 TIP SPEED = rpm x 12.632  
 MAX. MOTOR FRAME SIZE = 213T

Performance certified is for installation type A: Free inlet, Free outlet. Power rating (Bhp) does not include transmission losses. Performance ratings include the effects of a birdscreen in the airstream. The sound ratings shown are loudness values in fan sones at 5 feet (1.5 m) in a hemispherical free field calculated per AMCA Standard 301. Values shown are for installation type A: Free inlet hemispherical sones.

# LB/LBP 54 Belt Drive



## LB Dimensions

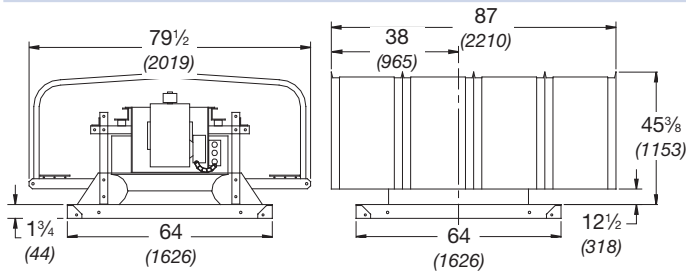

## LBP Dimensions

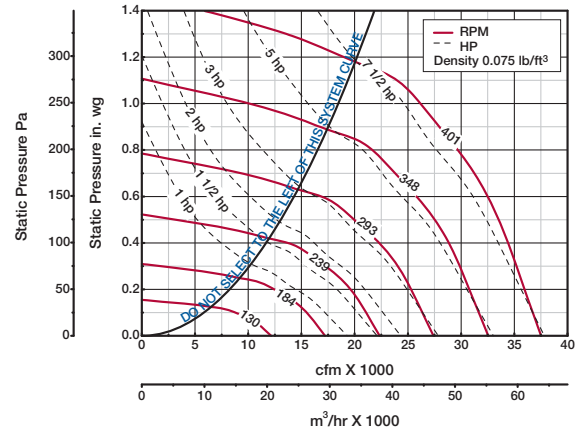
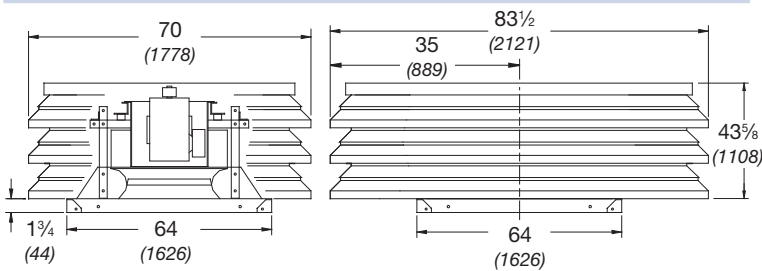

	LB-54	LBP-54
Hood Thickness	0.064 (0.029)	-
Cover Thickness	-	0.064 (0.029)
Louver Thickness	-	0.081 (0.036)
Curb Cap Thickness	0.064 (0.029)	0.064 (0.029)
Damper Size Square	54 (1372)	54 (1372)
Roof Opening Square	56 1/2 (1435)	56 1/2 (1435)
Weight*	Galvanized 596 (270)	Aluminum 780 (354)

All dimensions are in inches (millimeters). Weight in pounds (kilograms).  
\*Weight shown is the largest cataloged Open Drip Proof motor.  
See page 11 for severe duty LBP dimensions.

Model Number	Motor HP	Fan RPM	CFM / Static Pressure in Inches wg													
			0	0.125	0.25	0.375	0.5	0.625	0.75	0.875	1	1.125				
LB/LBP-54-10	1	130	CFM	12159												
			BHP	0.25												
			Sones	4.6												
		155	CFM	14497	11186											
			BHP	0.42	0.48											
			Sones	5.8	4.9											
		206	CFM	19267	17356	13895										
			BHP	0.99	1.1	1.12										
			Sones	8.7	8.5	8.7										
LB/LBP-54-15	1 1/2	235	CFM	21980	20319	17983	14194									
			BHP	1.47	1.6	1.66	1.6									
			Sones	11.2	11.2	11.3	11.7									
LB/LBP-54-20	2	258	CFM	24131	22628	20831	17904									
			BHP	1.95	2.09	2.18	2.21									
			Sones	12.1	12.5	13.0	13.3									
LB/LBP-54-30	3	277	CFM	25908	24517	22962	20554	17326								
			BHP	2.41	2.57	2.68	2.72	2.65								
			Sones	14.1	13.4	14.1	14.4	13.7								
		296	CFM	27685	26383	25030	23122	20394	16072							
			BHP	2.94	3.11	3.25	3.31	3.34	3.1							
			Sones	17.6	15.5	15.2	16.0	15.1	13.1							
LB/LBP-54-50	5	323	CFM	30210	29017	27789	26305	24165	21535	17215						
			BHP	3.82	4.01	4.17	4.27	4.31	4.29	4.01						
			Sones	19.3	17.8	17.3	18.4	18.3	16.8	14.7						
		350	CFM	32736	31634	30514	29312	27766	25487	22974	18944					
			BHP	4.87	5.06	5.25	5.39	5.46	5.5	5.43	5.13					
			Sones	18.9	19.5	20	21	22	21	19.0	17.8					
LB/LBP-54-75	7 1/2	376	CFM	35167	34142	33111	32039	30716	29030	26889	24483	20824				
			BHP	6.03	6.25	6.45	6.62	6.72	6.79	6.82	6.71	6.4				
			Sones	22	23	23	24	25	26	24	22	21				
		401	CFM	37506	36544	35583	34583	33500	32150	30332	28324	26018	22767			
			BHP	7.32	7.54	7.77	7.96	8.11	8.19	8.24	8.29	8.13	7.81			
			Sones	25	26	26	27	28	29	29	27	26	24			

MAX. BHP AT A GIVEN RPM - (rpm/198)<sup>3</sup>  
 MAXIMUM FRPM = 401  
 TIP SPEED = rpm x 14.137  
 MAX. MOTOR FRAME SIZE = 215T

Performance certified is for installation type A: Free inlet, Free outlet. Power rating (Bhp) does not include transmission losses. Performance ratings include the effects of a birdscreen in the airstream. The sound ratings shown are loudness values in fan sones at 5 feet (1.5 m) in a hemispherical free field calculated per AMCA Standard 301. Values shown are for installation type A: Free inlet hemispherical sones.



## Direct Drive Specifications

The LD and LDP exhaust fans shall be direct drive type. The fan wheel shall be centrifugal backward inclined, constructed of aluminum and shall include a wheel cone carefully matched to the fan's venturi for precise running tolerances. Wheels shall be statically and dynamically balanced. The fan shall be constructed of heavy gauge steel or aluminum with a rigid internal support structure and a birdscreen.

Motors shall be mounted on vibration isolators. Motors shall be readily accessible for maintenance.

A disconnect switch shall be factory installed and wired from the fan motor to a junction box within the motor compartment. A conduit chase shall be provided through the curb cap to the motor compartment for ease of electrical wiring.

All fans shall bear the AMCA Certified Ratings Seal for Sound and Air Performance.

Each fan shall bear a permanently affixed manufacturer's engraved aluminum nameplate containing the model number and individual serial number for future identification.

Fans shall be models LD or LDP as manufactured by Greenheck Fan Corporation in Schofield, Wisconsin, USA.

## Belt Drive Specifications

The LB and LBP exhaust fans shall be belt drive type. The fan wheel shall be centrifugal backward inclined, constructed of aluminum and shall include a wheel cone carefully matched to the fan's venturi for precise running tolerances.

Wheels shall be statically and dynamically balanced. The fan shall be constructed of heavy gauge steel or aluminum with a rigid internal support structure and birdscreen.

Motors shall be heavy duty ball bearing type, carefully matched to the fan load, and furnished at the specified voltage, phase and enclosure. Drive frame assembly shall be constructed of heavy gauge steel. Motors and drives shall be mounted on vibration isolators. Motors and drives shall be readily accessible for maintenance.

Precision ground and polished fan shafts shall be mounted in permanently sealed, lubricated pillow block ball bearings. Bearings shall be selected for a minimum  $L_{10}$  life in excess of 100,000 hours ( $L_{50}$  average of 500,000 hours) at maximum cataloged operating speed. Drives shall be sized for a minimum of 150% of driven horsepower. Pulleys shall be of the cast type, keyed and securely attached to the wheel and motor shafts.

Motor pulleys shall be adjustable for final system balancing. A disconnect switch shall be factory installed and wired from the fan motor to a junction box installed within the motor compartment. A conduit chase shall be provided through the base to the motor compartment for ease of electrical wiring.

All fans shall bear the AMCA Certified Ratings Seal for Sound and Air Performance.

Each fan shall bear a permanently affixed manufacturer's engraved aluminum nameplate containing the model number and individual serial number for future identification.

Fans shall be models LB or LBP as manufactured by Greenheck Fan Corporation in Schofield, Wisconsin, USA.



## Vari-Green® Motor

Motor to be an electronic commutation (EC) motor specifically designed for fan applications. AC induction type motors are not acceptable. Examples of unacceptable motors are: Shaded Pole, Permanent Split Capacitor (PSC), Split Phase, Capacitor Start and 3 phase induction type motors. Motors shall be permanently lubricated with heavy-duty ball bearings to match the fan load and prewired to the specific voltage and phase. Internal motor circuitry shall convert AC power supplied to the fan to DC power to operate the motor. Motor shall be speed controllable down to 20% of full speed (80% turndown). Speed shall be controlled by either a potentiometer dial mounted on the motor or by a 0-10 VDC signal. Motor shall be a minimum of 85% efficient at all speeds.

## Vari-Green Control - Remote Dial

Remote Dial shall be a Vari-Green control specifically designed to provide 0-10 volt DC signal to Greenheck's Vari-Green Motor.

## Vari-Green Control - Two Speed

Two-speed control shall be a Vari-Green Control specifically designed to allow the Vari-Green Motor to operate at two discrete speeds. Two speed control shall include two dials that may be set at any point between 0 and 10 volts DC and an integral transformer capable of reducing 115/208-240 volt AC power to 24 volt AC power.

## Vari-Green Control - Constant Pressure

Control to be a packaged constant pressure control designed to regulate fan speed based on demand. Control shall include a Proportional Integral Derivative (PID) feedback loop and shall have all components prewired to labeled terminal strips for easy wiring. Fan shall be direct drive including an electronic commutation (EC) Vari-Green Motor. Control package shall be Vari-Green Constant Pressure or Airflow Control.

Control with integral pressure transducer shall be a NEMA-4 rated enclosure with built in pressure transducer. The proper pressure/airflow tap for the application shall be supplied.

Control with remote pressure transducer shall be a NEMA-4 rated enclosure for both the controller and remote transducer. The proper pressure/airflow tap for the application shall be supplied.

## LEED information



Greenheck became one of the first manufacturers in the Air Movement and Control industry to join the LEED/green movement when they joined the United States Green Building Council (USGBC) in 2005. Greenheck has been actively researching qualification requirements for our products to meet LEED credits and prerequisites.

The Vari-Green motor significantly helps qualification efforts for the Energy and Atmosphere credits and prerequisites; specifically credit one, Optimize Energy Performance and prerequisite two, Minimum Energy Performance.

# Extraordinary Service



## Enjoy Greenheck's extraordinary service, before, during and after the sale.

Greenheck offers added value to our wide selection of top performing, energy-efficient products by providing several unique Greenheck service programs.

- Our Quick Delivery Program ensures shipment of our in-stock products within 24 hours of placing your order. Our Quick Build made-to-order products can be produced in 1-3-5-10-15 or 25-day production cycles, depending upon their complexity.
- Greenheck's free Computer Aided Product Selection program (CAPS), rated by many as the best in the industry, helps you conveniently and efficiently select the right products for the challenge at hand.
- Greenheck has been Green for a long time! Our energy-saving products and ongoing corporate commitment to sustainability can help you qualify for LEED credits.
- Our 3D service allows you to download, at no charge, easy-to-use AutoDesk™ Revit™ 3D drawings for many of our ventilation products.

Find out more about these special Greenheck services at [greenheck.com](http://greenheck.com)



## Building Value in Air

Greenheck delivers value to mechanical engineers by helping them solve virtually any air quality challenges their clients face with a comprehensive selection of

top quality, innovative air-related equipment. We offer extra value to contractors by providing easy-to-install, competitively priced, reliable products that arrive on time.

And building owners and occupants value the energy efficiency, low maintenance and quiet dependable operation they experience long after the construction project ends.

## Our Commitment

*As a result of our commitment to continuous improvement, Greenheck reserves the right to change specifications without notice.*

Specific Greenheck product warranties are located on [greenheck.com](http://greenheck.com) within the product area tabs and in the Library under Warranties.



Prepared to Support Green Building Efforts

